

---

# Xilos

TABLES

*Antonio Citterio*



## Description

The distinguishing feature of the Xilos table collection, available in a square version (178x178 cm) and three round sizes (Ø cm 160, Ø cm 178 and Ø cm 220), is its cross-shaped frame in grey oak, brushed light oak, brushed black oak, smoked oak, natural wenge or Sucupira. The round version is also available with a top in white Calacatta marble, Emperador marble, Guatemala green marble or Sahara noir marble and can be paired with a swivel tray in two sizes (Ø cm 70 and Ø cm 110 cm) and six finishes (the same types of wood as the frame or with a top in marble).

---

## Technical information

### Top:

veneered plywood panel with honeycomb-core and wood particles or wood particles panel with solid wood parts

### Top finish:

grey oak, brushed light oak, brushed black oak, smoked oak, natural wenge, Sucupira, Calacatta white marble (glossy polyester finish), Emperador marble (glossy polyester finish), Guatemala green marble (glossy polyester finish) or Sahara noir marble (glossy polyester finish)

### Frame:

grey oak, brushed light oak, brushed black oak, smoked oak, natural wenge or Sucupira veneered solid beechwood

### Swivel tray (SMTG7N-SMTG11):

HPL stratified laminate panel, veneered wood particles panel: grey oak, brushed light oak, brushed black oak, smoked oak, natural wenge, Sucupira, Calacatta white marble (glossy polyester finish), Emperador marble (glossy polyester finish), Guatemala green marble (glossy polyester finish) or Sahara noir marble (glossy polyester finish)

### Rotation mechanism (SMTG7N-SMTG11):

aluminium with steel balls

### Adjustable feet:

steel and plastic material

# Technical drawings

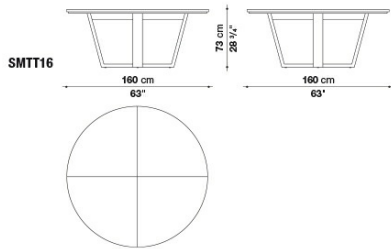

SMTT16

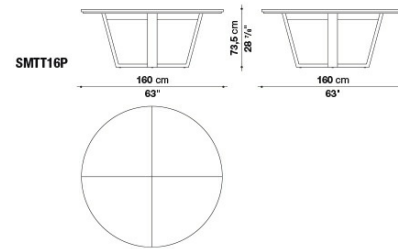

SMTT16P

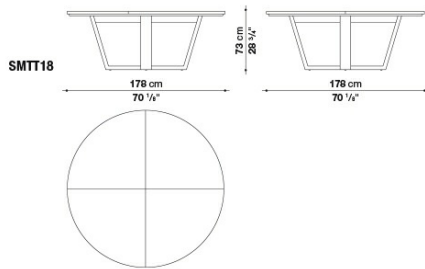

SMTT18

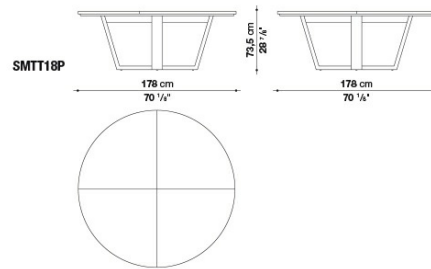

SMTT18P

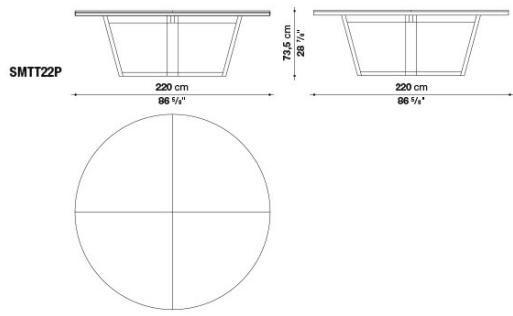

SMTT22P

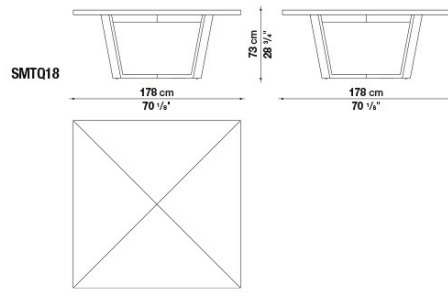

SMTQ18

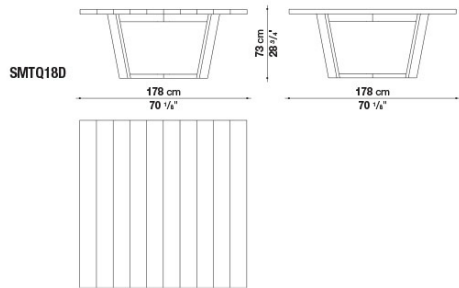

SMTQ18D

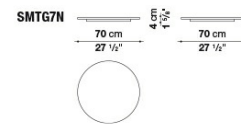

SMTG7N

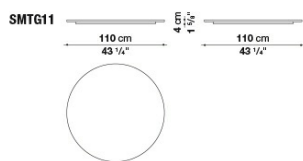

SMTG11

---

B&B Italia reserves the right to make technological and aesthetic improvements to its models, including changes to the sizes and materials, without notice. The technical drawings do not define the details of the product. The measurements shown are indicative and may undergo changes. In particular, the dimensions relevant to the padded parts are subject to usage tolerances over time caused by the normal adjustment of the padding. For the specific information, please contact the dealer closest to you.