

Rely ^{HW28-HW32}

Hee Welling

2021

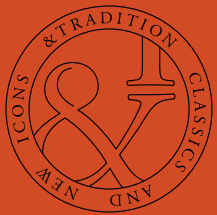

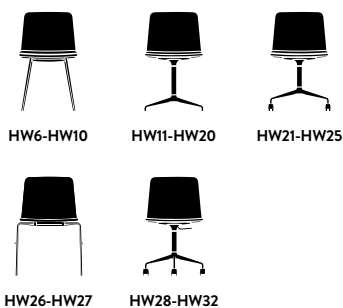

Rely Hee Welling 2020

RECYLING

The Rely is built to last, and we hope that your Rely will serve you for many years. Its shell is made from 100% recycled material, and can be easily separated from its base. All metal and plastic parts can be separated and delivered to a suitable recycling station.

SPARE PARTS

To purchase spare parts for your Rely chair, please write to our sales support team at info@andtradition.com with your query.

5 YEAR WARRANTY

&Tradition provides a 5-year warranty with every Rely chair, which covers faults which were present at the time of purchase, or which have occurred as a result of a manufacturing defect. The warranty is valid from the date stated on the original invoice.





HW28

Rely^{HW28} Hee Welling 2021

Product category
Chair w. plastic shell

Environment
Indoor

Production process
Shell made from 100% recycled polypropylene with 15% fiber glass. The swivel base with castors is made from extruded aluminium, which is polished or powder coated.
Seat pad available upon request.

Material
Polypropylene, glass fiber, polished or powder coated aluminium.
This product has not been treated with any biocides.

Base finishes
5-star base w. castors & gaslift
Polished aluminium or Black
Matching castors only

Shell colours
Black, White, Red Brown, Light Blue, Beige Sand, Stone Grey

Certifications



Strength, durability and safety testing
The chair is tested for strength, durability and safety according to: - EN 16139 Level 2 - Extreme use.

Related products



HW6-HW10 HW11-HW20 HW21-HW25 HW26-HW27



HW29-HW32



Dimensions

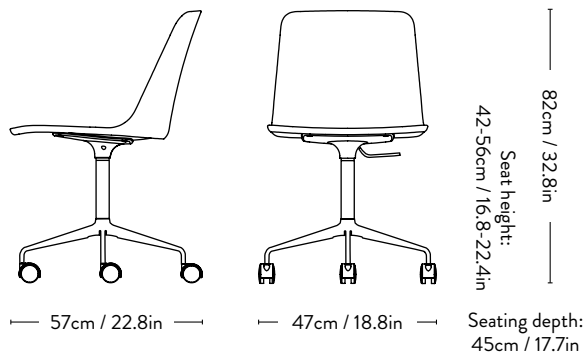



HW28

Rely^{HW28} Hee Welling 2021

Packaging dimensions

H:81cm / 31.9in
W:68cm / 26.8in
D:68cm / 26.8in

Weight

Product: 8.9 kg
Product incl. packaging: 12 kg

Manufacturer

Produced in Poland by Trio Line Polska Sp. z o.o.

Cleaning Instructions

Please click [here](#) to download our Material Care & Cleaning Instructions.

Base finishes



Black

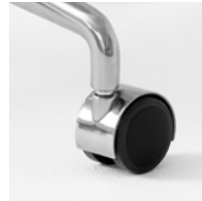

Polished Aluminium

Shell colours



Black



White

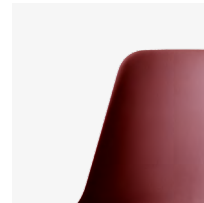

Red Brown



Light Blue

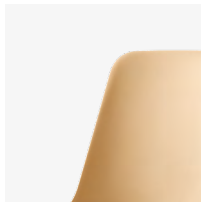

Beige Sand

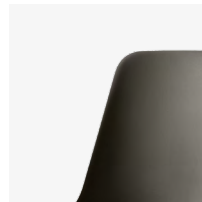

Stone Grey

Seat pad



* COM must be approved by &Tradition to ensure suitability for upholstery.



HW29

Rely^{HW29} Hee Welling 2021

Product category

Chair w. plastic shell & seat cushion

Environment

Indoor

Production process

Shell made from 100% recycled polypropylene with 15% fiber glass. Upholstered seats are made with a veneer plate with 30mm foam. The swivel base with castors is made from extruded aluminium, which is polished or powder coated.

Material

Polypropylene, glass fiber, polished or powder coated aluminium.

This product has not been treated with any biocides.

Base finishes

5-star base w. castors & gaslift
Polished aluminium or Black
Matching castors only

Shell colours

Black, White, Red Brown, Light Blue, Beige Sand, Stone Grey

Certifications

FSC Mix (C154398): Seat cushion



Strength, durability and safety testing

The chair is tested for strength, durability and safety according to: – EN 16139 Level 2 – Extreme use.

Related products



HW6-HW10



HW11-HW20



HW21-HW25



HW26-HW27



HW28 &
HW30-HW32

Dimensions

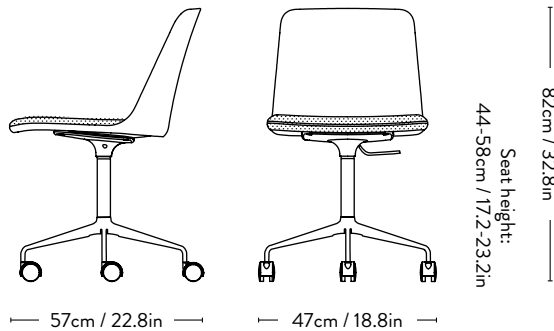



HW29

Rely^{HW29} Hee Welling 2021

Packaging dimensions

H:81cm / 31.9in

W:68cm / 26.8in

D:68cm / 26.8in

Weight

Product: 10.2 kg

Product incl. packaging: 13.3 kg

Seat Upholstery

Seat upholstery available in all fabrics, leathers and COM.

Fabric usage: 70x70cm (0.49 meter).

Leather usage: 100x100cm (1 square meter).

COM must be approved by &Tradition to ensure suitability for upholstery.

Manufacturer

Produced in Poland by Trio Line Polska Sp. z o.o.

Cleaning Instructions

Please click [here](#) to download our Material Care & Cleaning Instructions.

Base finishes

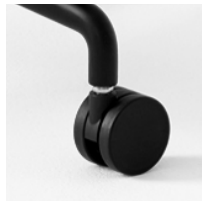

Black

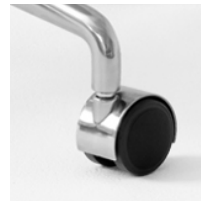

Polished Aluminium

Shell colours

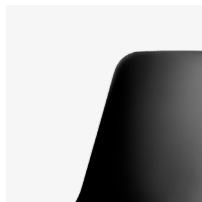

Black



White

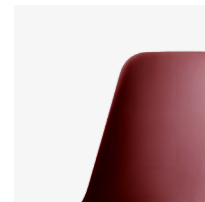

Red Brown

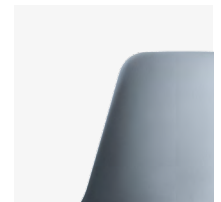

Light Blue

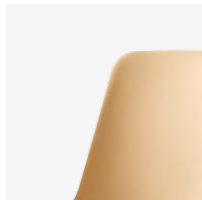

Beige Sand

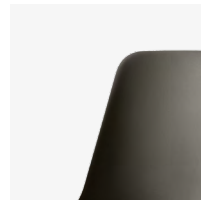

Stone Grey



HW30

Rely^{HW30} Hee Welling 2021

Product category
Upholstered chair

Environment
Indoor

Production process
Shell made from 100% recycled polypropylene with 15% fiber glass. Upholstered seats are made with a veneer plate with 30mm foam. The swivel base with castors is made from extruded aluminium, which is polished or powder coated.

Material
Polypropylene, glass fiber, polished or powder coated aluminium.

Base finishes
5-star base w. castors & gaslift
Polished aluminium or Black
Matching castors only

Certifications



Strength, durability and safety testing
The chair is tested for strength, durability and safety according to: - EN 16139 Level 2 - Extreme use.

Related products

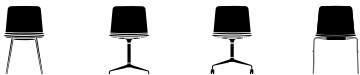

HW6-HW10 HW11-HW20 HW21-HW25 HW26-HW27



HW28-HW29
HW31-HW32



Dimensions

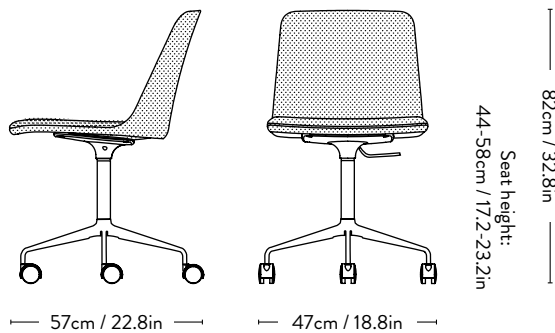



HW30

Rely^{HW30} Hee Welling 2021

Packaging dimensions

H:81cm / 31.9in

W:68cm / 26.8in

D:68cm / 26.8in

Weight

Product: 9.4 kg

Product incl. packaging: 12.5 kg

Seat Upholstery

Shell upholstery available in all fabrics, leathers and COM.

Fabric usage: 1.40 meters based on a 140cm roll.

Leather usage: 2.2 square meters.

COM must be approved by &Tradition to ensure suitability for upholstery.

Manufacturer

Produced in Poland by Trio Line Polska Sp. z o.o.

Cleaning Instructions

Please click [here](#) to download our Material Care & Cleaning Instructions.

Base finishes

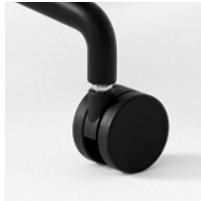

Black

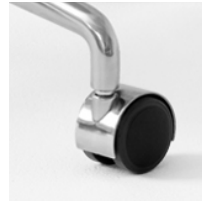

Polished Aluminium



HW31 & HW32

Rely^{HW31 & HW32} Hee Welling 2021

Product category

Upholstered chair w. seat cushion

Environment

Indoor

Production process

Shell made from 100% recycled polypropylene with 15% fiber glass. Upholstered seats are made with a veneer plate with 30mm foam. The swivel base with castors is made from extruded aluminium, which is polished or powder coated.

Material

Polypropylene, glass fiber, polished or powder coated aluminium.

This product has not been treated with any biocides.

Base finishes

5-star base w. castors & gaslift
Polished aluminium or Black
Matching castors only

Shell colours

Black, White, Red Brown, Light Blue, Beige Sand, Stone Grey

Certifications

FSC Mix (C154398): Seat cushion



Strength, durability and safety testing

The chair is tested for strength, durability and safety according to: – EN 16139 Level 2 – Extreme use.

Related products



HW6-HW10



HW11-HW20



HW21-HW25



HW26-HW27



HW28-HW30

Dimensions

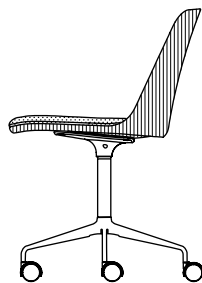

— 57cm / 22.8in —

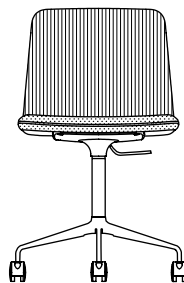

— 47cm / 18.8in —

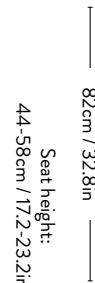

82cm / 32.8in
Seat height:
44-58cm / 17.2-23.2in

Seating depth:
45cm / 17.7in



HW31 & HW32

Rely^{HW31 & HW32} Hee Welling 2021

Packaging dimensions

H:81cm / 31.9in
W:68cm / 26.8in
D:68cm / 26.8in

Weight

Product: 10.5 kg
Product incl. packaging: 13.6 kg

Seat Upholstery

HW31: Shell + seat upholstery available in all fabrics, leathers and COM (mono upholstery)
Fabric usage: 1.8 meters based on a 140cm roll.
Leather usage: 2.7 square meters

HW32: Upholstered shell with a mixed seat upholstery available in all fabrics, leathers and COM. Fabric usage: 1.9 meter (Shell: 1.2 meters / Seat: 0.7 meter). Leather usage: 2.9 square meters (Shell: 2 sqm / Seat: 0.9 sqm).
COM must be approved by &Tradition to ensure suitability for upholstery.

Manufacturer

Produced in Poland by Trio Line Polska Sp. z o.o.

Cleaning Instructions

Please click [here](#) to download our Material Care & Cleaning Instructions.

Base finishes

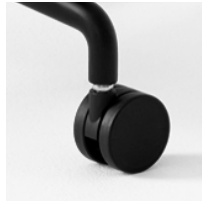

Black

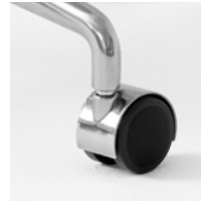

Polished Aluminium