



SINGLE CURVE BARSTOOL & COUNTER

TECHNISCHES BLATT
SCHEDA TECNICA
DATA SHEET
FICHE TECHNIQUE

SINGLE CURVE BARSTOOL & COUNTER

DESIGN NENDO, 2015



Barhocker aus Buchenbugholz. Sitz aus Schichtholz oder Wiener Geflecht. Fußstütze mit Messing beschichtet.

Sgabello da bar in faggio curvato. Seduta in multistrato o in paglia di Vienna. Barra poggiapiedi rivestita in ottone.



Bent beech-wood barstool. Plywood or woven cane seat. Brass covered footrest.

Tabouret bar en hêtre cintré. Assise en contreplaqué ou en paille de Vienne. Barre repose-pied recouverte de laiton.

Counter Hocker aus Buchenbugholz. Sitz aus Schichtholz oder Wiener Geflecht. Fußstütze mit Messing beschichtet.

Sgabello counter in faggio curvato. Seduta in multistrato o in paglia di Vienna. Barra poggiapiedi rivestita in ottone.

Bent beech-wood counter stool. Plywood or woven cane seat. Brass covered footrest.

Tabouret bar en hêtre cintré, assise h 65 cm. Assise en contreplaqué ou en paille de Vienne. Barre repose-pied recouverte de laiton.



SANSTOLGN

Dimensions mm.

height 870 | width 540 | depth 420



SANSTOPGL

Dimensions mm.

height 870 | width 540 | depth 420



SMNSTOLGN

Dimensions mm.

height 780 | width 540 | depth 420



SMNSTOPGL

Dimensions mm.

height 780 | width 540 | depth 420

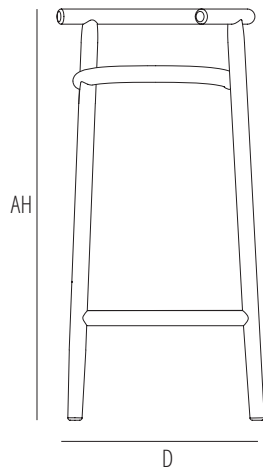
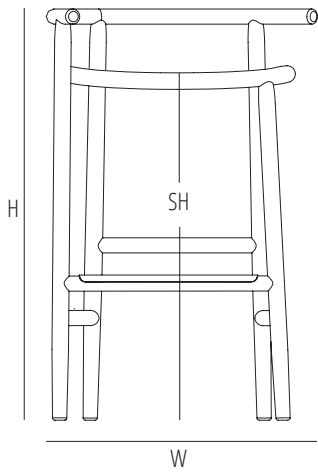

	H	W	D	SH	AH
mm	870	540	420	740	870
inch	34,2	21,2	16,5	29,1	34,2

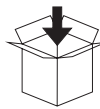
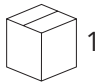

max. 1

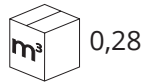

0,28

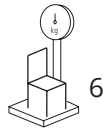

6

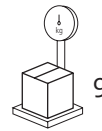

9

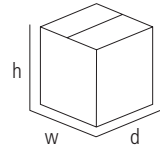

mm - inch
h 1000 - 39,3
w 500 - 19,6
d 500 - 19,6

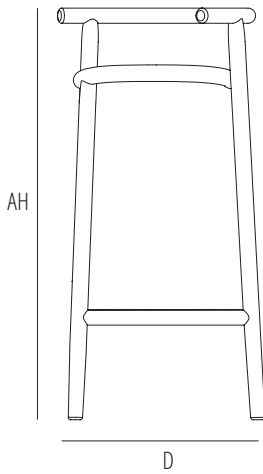
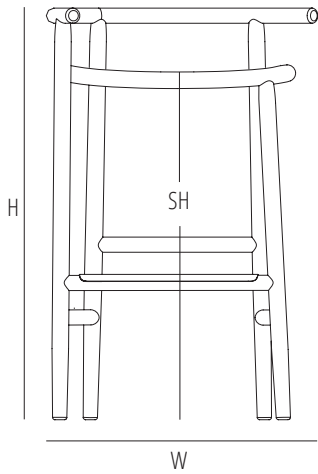

	H	W	D	SH	AH
mm	870	540	420	740	870
inch	34,2	21,2	16,5	29,1	34,2

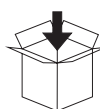
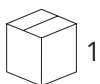

max. 1

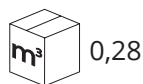

0,28

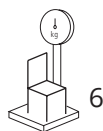

6

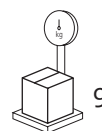

9

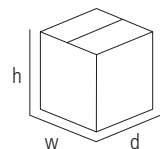

mm - inch
h 1000 - 39,3
w 500 - 19,6
d 500 - 19,6

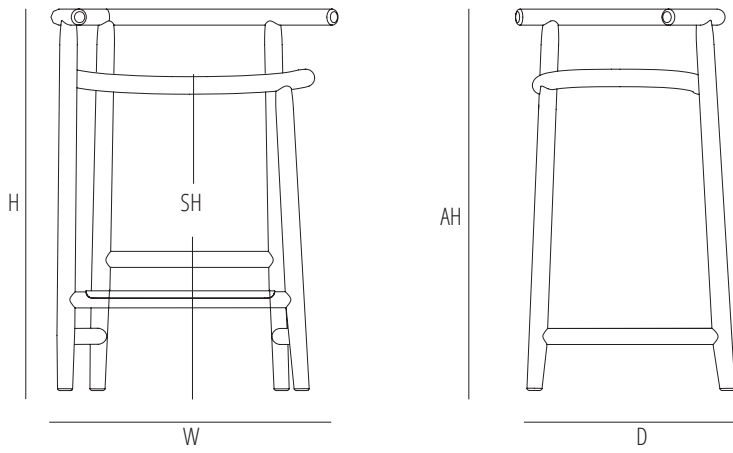

	H	W	D	SH	AH
mm	780	540	420	650	780
inch	30,7	21,2	16,5	25,6	30,7

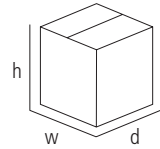
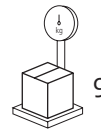
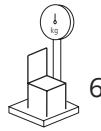
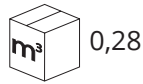
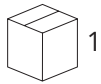

mm - inch
h 850 - 33,5
w 500 - 19,6
d 550 - 21,6

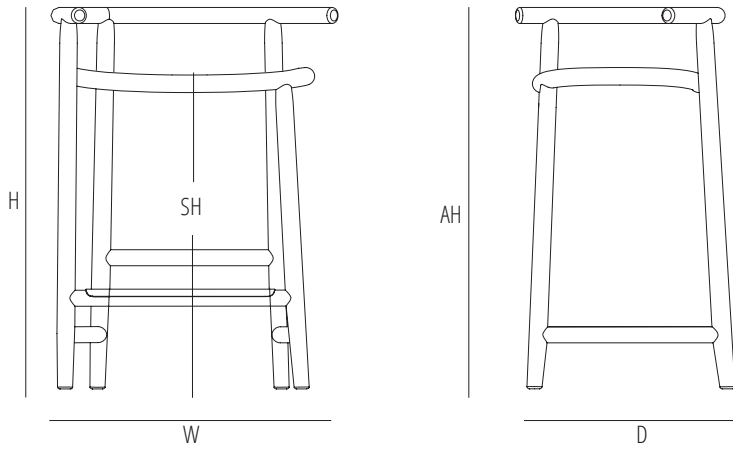

	H	W	D	SH	AH
mm	780	540	420	650	780
inch	30,7	21,2	16,5	25,6	30,7

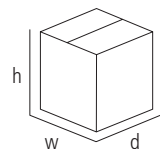
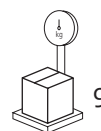
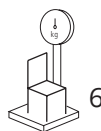
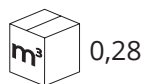
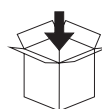
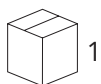

mm - inch
h 850 - 33,5
w 500 - 19,6
d 550 - 21,6

Verfuegbare Ausfuehrungen
 Finiture disponibili
 Available finishes
 Finitions disponibles

SOLID WOOD / ESSENZE NATURALI



B01 BEECH
 B01 FAGGIO

STAINS / TINTI



B03 DARK WALNUT
 B03 NOCE SCURO



B04 WENGÈ
 B04 WENGÈ



B05 BEECH GLOSS O
 B05 FAGGIO GLOSS O

CLASSIC LACQUER / LACCATO CLASSICO

*Ash wood is open-pore painted
 * L'essenza frassino è verniciata a poro aperto



C01 - RAL 9005 BLACK

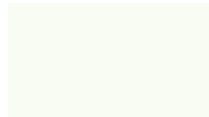

C02 - RAL 9010 PURE WHITE

CONTEMPORARY LACQUER / LACCATO CONTEMPORANEO

*Ash wood is open-pore painted
 * L'essenza frassino è verniciata a poro aperto



D01 - RAL 1013 PEARL WHITE



D02 - RAL 7047 TELEGREY 4



D03 - RAL 7030 STONE GREY



D19 - S7502 G DARK GREY



D21 - S1510 Y80R POWDER PINK



D20 - S2570 Y60R ORANGE



D10 - RAL 3000 FLAME RED



D14 - RAL 3005 WINE RED



D22 - S1515 R90B LIGHT BLUE



D11 - RAL 7000 SQUIRREL GREY



D12 - RAL 7031 BLUE GREY



D25 - RAL 5011 STEEL BLUE



D15 - RAL 5020 OCEAN BLUE



D24 - S2070 Y10R YELLOW OCRE



D07 - RAL 1027 CURRY YELLOW



D23 - S6020 G10Y DARK GREEN

Gebrüder Thonet Vienna GmbH
Prinz Eugen Straße 42
1040 Wien (AT)

www.gebruederthonetvienna.com

Offices of the trademarks' licensee
Production Furniture International S.p.A.
Via Foggia, 23/H
10152 Torino (TO) Italy

Phone: 0039 011 0133330 - info@gebruederthonetvienna.com