

57

A fabrication process whereby air voids of different sizes and configurations are composed within a larger mass of dark grey glass. These air pockets are invisible when the piece is unlit, and come alive to reveal an interior universe when 57 is illuminated. By virtue of the method of making, each 57 is completely unique. A flexible suspension system enables pendants to be nestled in close-knit groups or loosely composed in a wider field, allowing each piece to be perceived individually.



57

Lamping

1.8w LED

Material

blown and dipped glass, cast borosilicate glass cap, powder coated steel and brass hardware, swag hooks, braided metal coaxial cable, aircraft cable, electrical components, and brass or white powder coated canopy.

Patent

EU Patent # 000268581-0001 to 0006
Worldwide patents issued and pending



LOW VOLTAGE LUMINAIRE
E476186



±100-165
(4"-6")

57

random

Adjustable Lengths
Random canopies

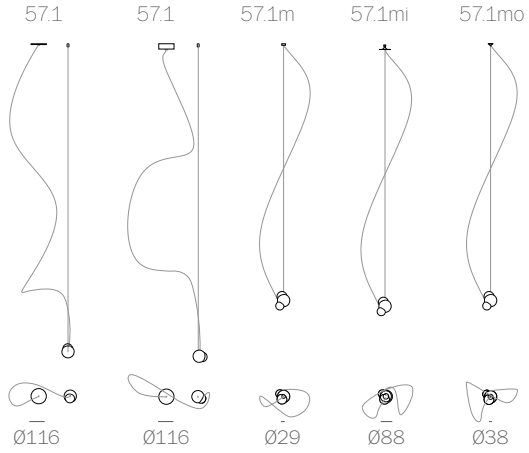

adjustable up to 3000 (10') standard
adjustable up to 24600 (80') custom

Fixed Lengths
Random canopies.

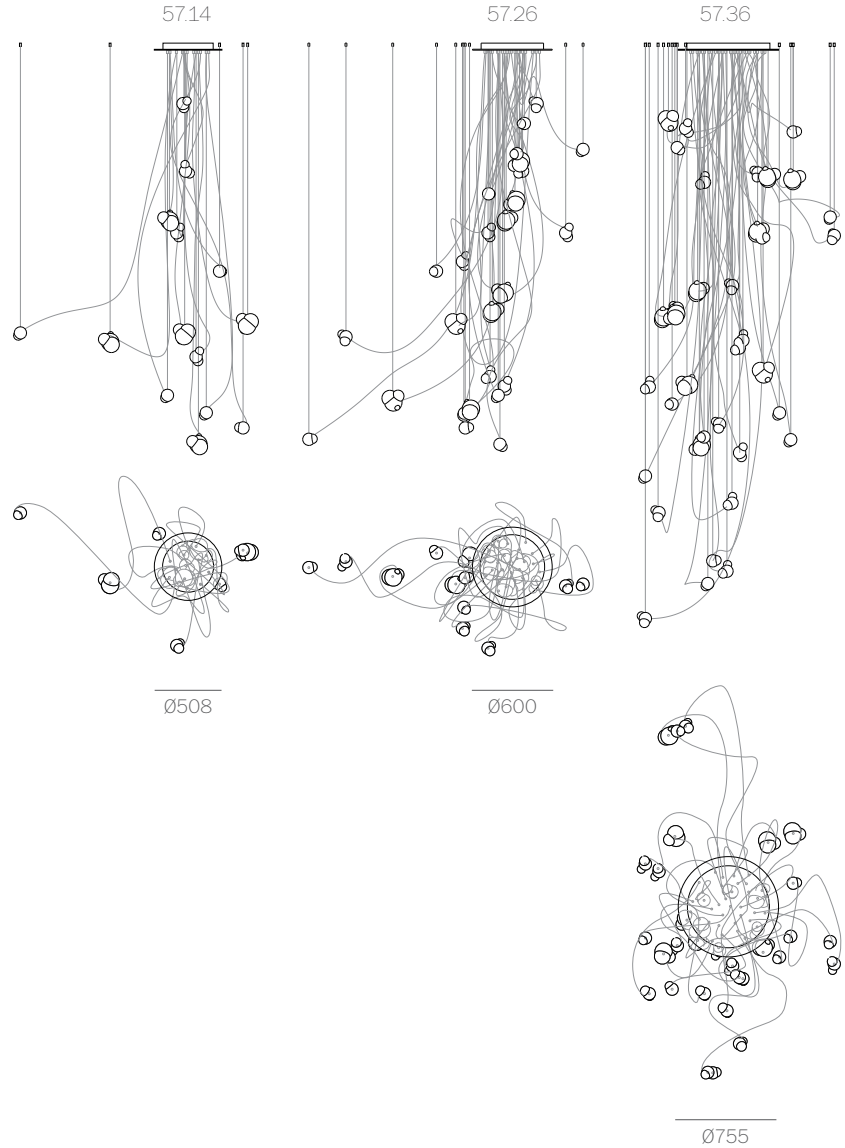

fixed length up to 3000 (10') standard
fixed length up to 24600 (80') custom

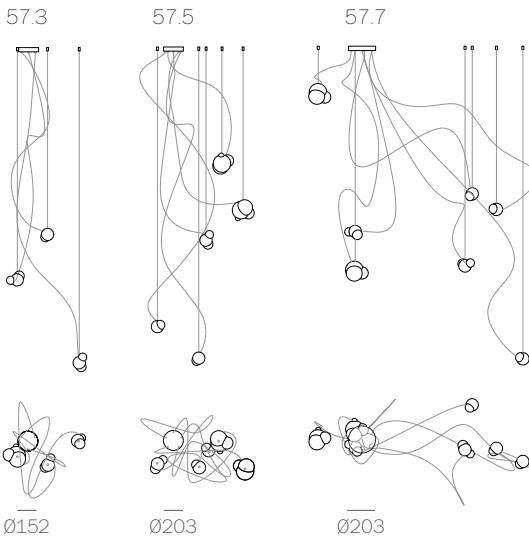

adjustable up to 3000 (10') standard
adjustable up to 24600 (80') custom

57

cluster

Adjustable Lengths
Cluster canopies.

57.3

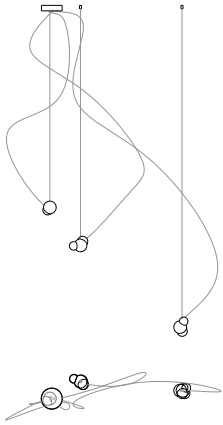

Ø152

57.7

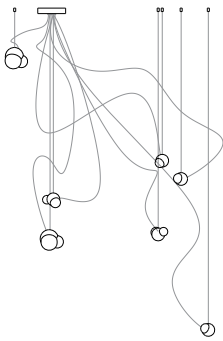

Ø203

adjustable up to 3000 (10') standard

adjustable up to 24600 (80') custom

Fixed Lengths
Cluster canopies.

57.19

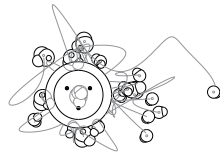
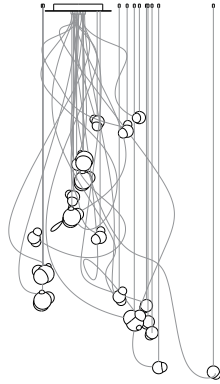

Ø501

57.37

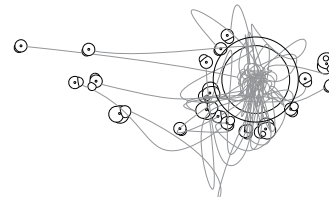
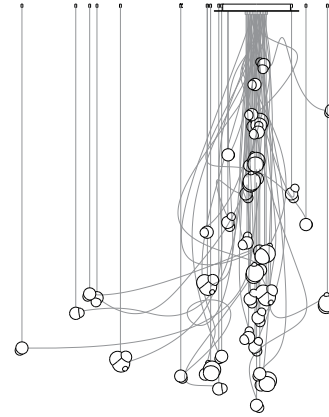

Ø600

57.61

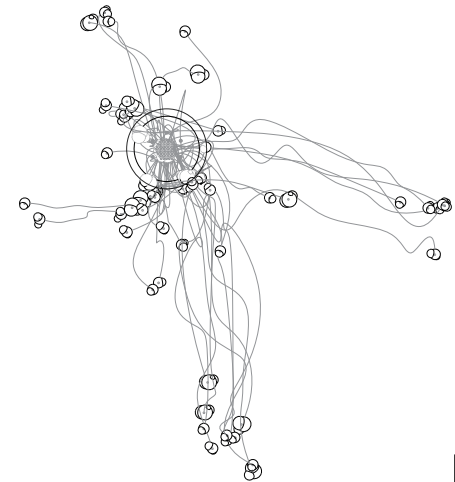
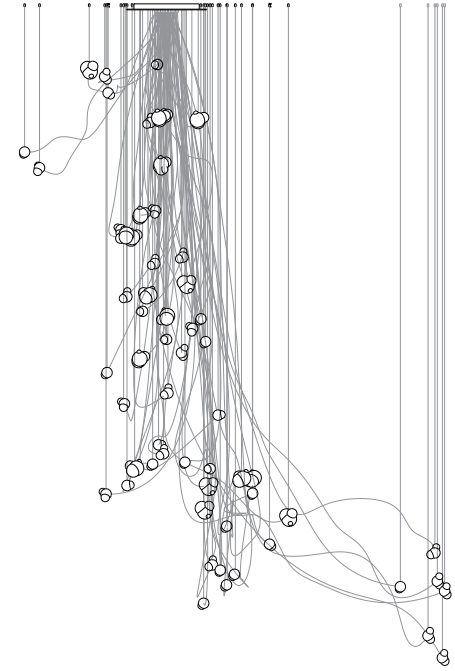

fixed length up to 3000 (10') standard

fixed length up to 24600 (80') custom

Ø707

57



57

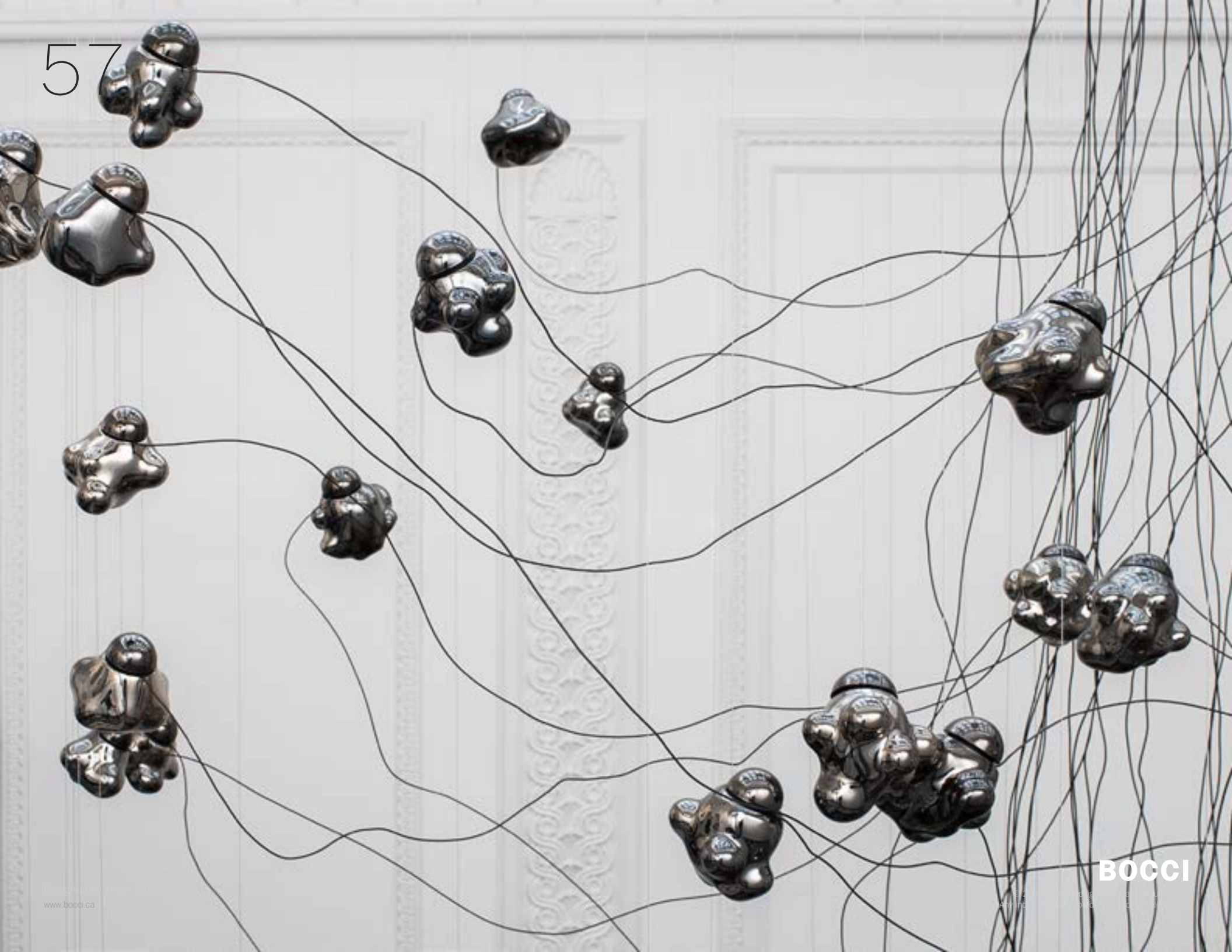

BOCCI



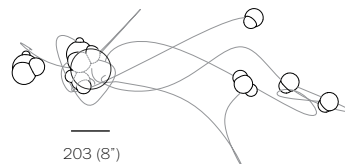
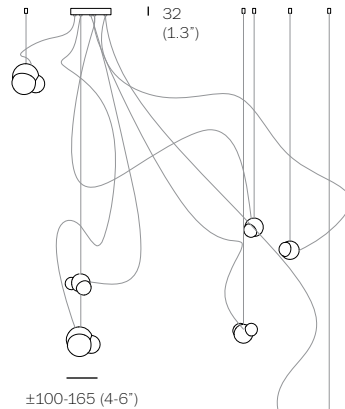
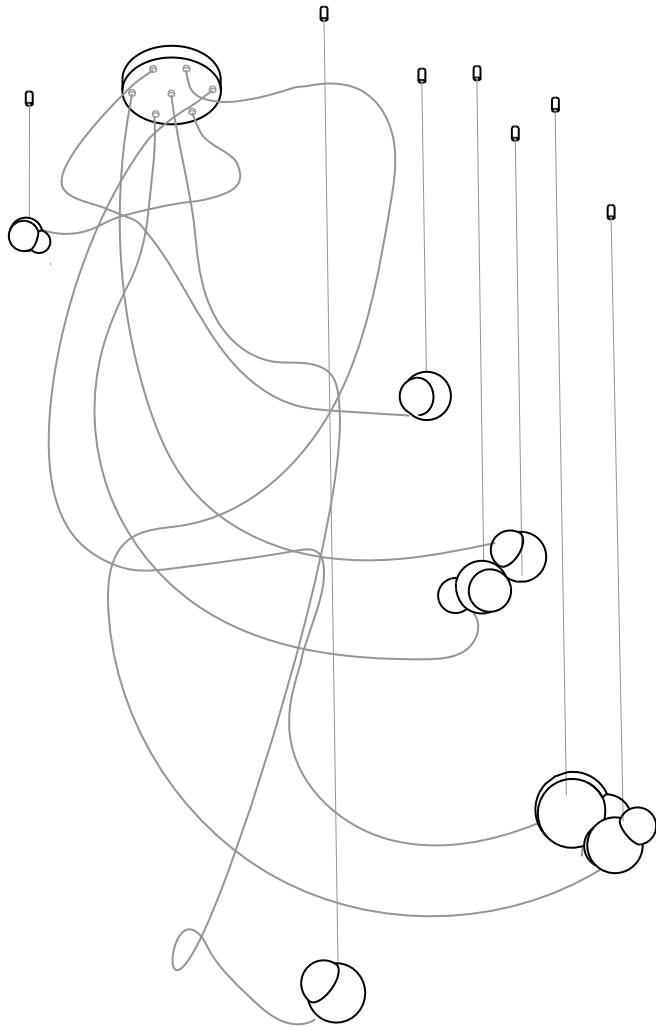

adjustable
up to 3000
(10')
standard

adjustable
up to
24600
(80')
custom
max.

- PENDANTS: seven
- MOUNTING: brass canopy 203mm (8") in diameter x 32mm (1.3") deep
- LAMPING: 1.8w LED (13w total)
- CABLE: adjustable. 3000mm (10') standard / up to 24600mm (80') maximum
- MATERIALS: blown and dipped glass, cast borosilicate glass cap, powder-coated steel and brass hardware, swag hooks, braided metal coaxial cable, aircraft cable, electrical components.
- WEIGHT: approximately 11kg (25lb)
- TRANSFORMERS: integral

DESCRIPTION

57.7 is a random configuration of seven 57 pendants suspended from a brass canopy. This chandelier is designed to be horizontal, meaning that the pendants don't hang directly below, but instead trail off across a space, around a corner or simply deviate from their gravitational directive. As such, this chandelier is designed to be hung from any number of optional swag points mounted elsewhere from the canopy.

57 is an exploration of a technique used for producing closed cell foam. The process involves trapping voids of air of different sizes and configurations within a glass matrix, yielding a shape loosely referencing a rain cloud. These pockets of air remain invisible when the piece is off, but come alive to reveal an interior universe when the piece is illuminated. By virtue of the fabrication process, each piece is completely unique.

NOTES

+ Purchase replacement lamps online at www.bocci.ca/lamps

EU Patent # 002268581-0001 to 0006
Worldwide patents issued and pending

Made in Vancouver, Canada

Vancouver
sales@bocci.ca
www.bocci.ca

Berlin
europe@bocci.ca
www.bocci.ca

approx 11kg (25lb)

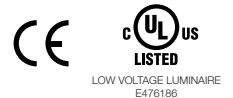

57.7

Design by Omer Arbel
PRODUCT SPECIFICATION

BOCCI

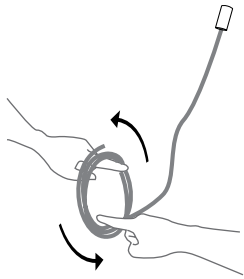

1

Very carefully uncoil the braided coaxial cable in a spool like manner. Insert your index fingers into opposite sides of the roll then rotate your fingers around each other to unroll the coaxial cable.

Use patience: allow the cable to uncoil completely to avoid kinks.

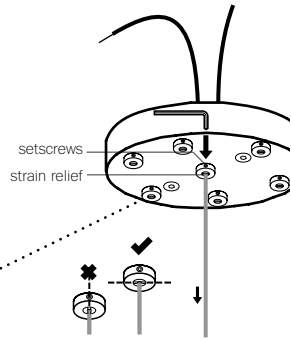

2

Thread the coaxial cables through the canopy, use a 2mm Allen key to loosen the setscrew in the canopy and gently feed the cable through until you have reached your desired drop length.

Use Allen key to tighten the setscrew to hold the strain relief and secure the coaxial cable at its new length. Perform a gentle tug test to ensure it is secure.

DO NOT OVERTIGHTEN.

Note: The strain relief is a black plastic collar around the coaxial cable. There is a single slot opening on the side of the strain relief component. It is essential that this opening is oriented at 90 degrees to set screw chamber. There can be no contact between the set screw and the cable.

RISK OF ELECTRIC SHORT!

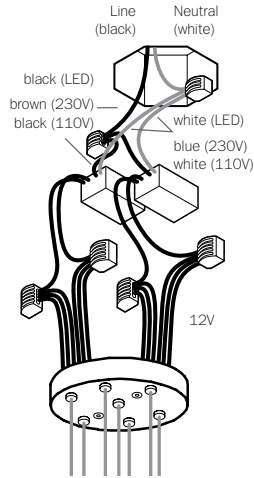

3

LED: connect the black wire to black and white wire to white wire.

Connect the coaxial cable to the open slots in the terminal block on the 12V side of the transformers.

Ensure that the braided outer wires are all connected to one 12V output wire and all inner insulated wires are connected to the other or a short will occur.

Once all coaxial connections are made, lift the fixture into position and connect the line voltage to the open slot in the appropriate terminal block.

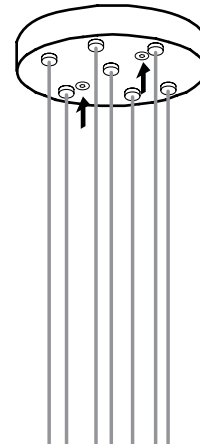

4

The client is responsible to ensure fasteners are attached to a robust structural substrate.

Tuck the transformer and wiring into the canopy. Line up the fastener holes or connect directly to structural ceiling surface using the fasteners provided.

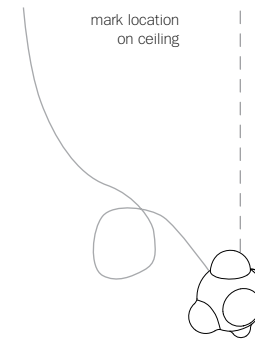

5

Move pendant into location and mark the location for the swag hook screw on the ceiling.

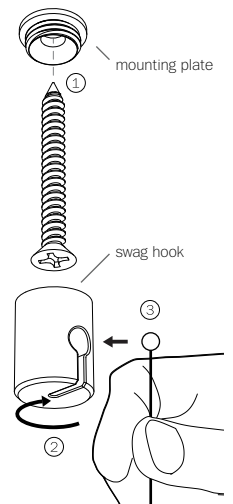

6

Ensure that the ceiling at the swag location is strong enough to hold 2kg (5lbs) before attaching swag hook with the provided screws.

Thread the swag hook on to the mounting plate, ensuring all the threads are engaged.

Slide the ball end of the aircraft into the slot on the swag hook.

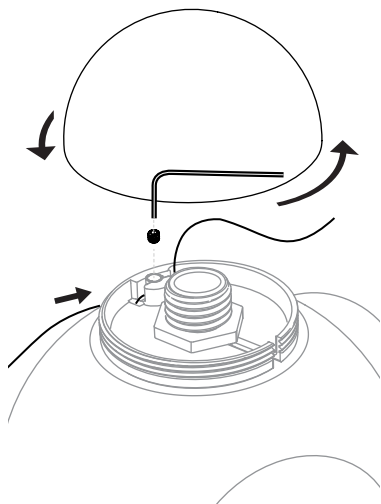

8

Remove the glass cap by turning counter-clockwise and set aside.

Note: throughout the installation, be mindful not to damage the glass cap and do not lose track of it, its size was chosen specifically for this pendant.

Using a 2mm Allen key, loosen the set screw on the hardware. Insert the aircraft cable into the small hole.

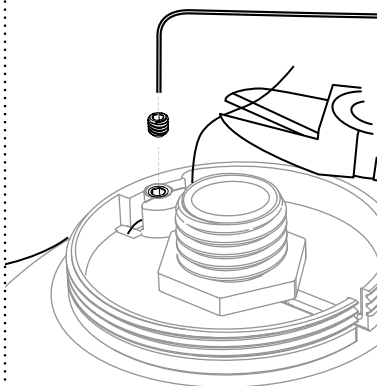

9

Once the pendant is positioned at the desired height, tighten the set screw to lock in the aircraft cable.

Using wire cutters, trim off any excess aircraft cable.

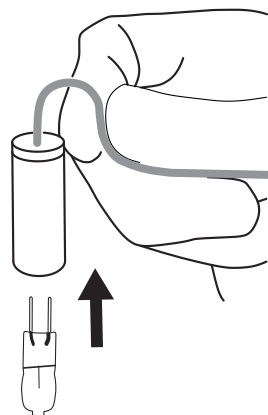

10

Form a hook-shape in the coax right above the lampholder pinching it together over your index finger or thumb. The lampholder should be roughly 90 degrees to the rest of the length of coax.

Bocci 1.8w LED lamps included.

Plug the lamp into the socket. Do not touch the lamp with your bare hands.

Purchase replacement lamps online at www.bocci.ca/lamps

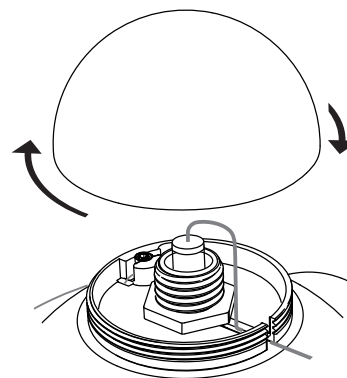

11

Insert the lampholder into the pendant through the hole in the centre of the cap mount. Set it in such a way that the crook rests parallel to the cap mount and runs through the slot with the lampholder inside the pendant perpendicular to the cap mount.

Put the cap back onto the pendant, ensuring that the coax remains seated in the slot. Thread the cap onto the mount.

DO NOT OVERTIGHTEN.

There should be a 2mm gap between the cap and the pendant with the coax emerging from inside.

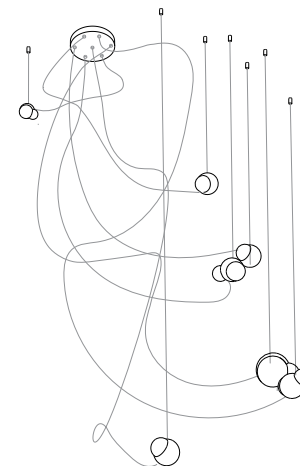

12

Clean fingerprints from glass surfaces.

Turn fixture on.

For additional assistance, please contact Bocci:

Vancouver
sales@bocci.ca
www.bocci.ca

Berlin
europe@bocci.ca
www.bocci.ca

EU Patent # 002268581-0001 to 0006
Worldwide patents issued and pending

Made in Vancouver, Canada



LOW VOLTAGE LUMINAIRE
E476186

57.7

Design by Omer Arbel
PRODUCT INSTALLATION INSTRUCTIONS

© 2018, Bocci Design and Manufacturing Inc. All rights reserved. Any inquiries should be directed to: info@bocci.ca

BOCCI

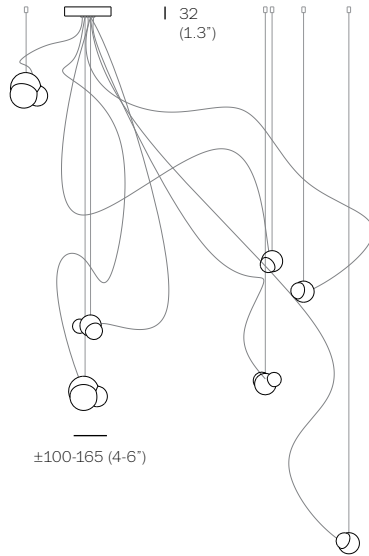

±100-165 (4-6')

up to
3000
(10')
standard

up to
24600
(80')
custom

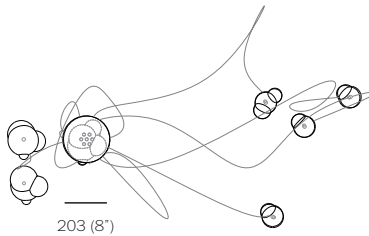

203 (8')

- PENDANTS: seven
- MOUNTING: brass canopy 203mm (8") in diameter x 32mm (1.3") deep
- LAMPING: 1.8w LED (26w total)
- CABLE: adjustable. 3000mm (10') standard / up to 24600mm (80') maximum
- MATERIALS: blown and dipped glass, cast borosilicate glass cap, brass hardware and swag hooks, braided metal coaxial cable, aircraft cable, electrical components..
- WEIGHT: approximately 11kg (25lb)
- TRANSFORMERS: integral

DESCRIPTION

57.7 is a cluster configuration of seven 57 pendants suspended from a round canopy. This fixture is designed to be horizontal, meaning that the pendants don't hang directly below, but instead trail off across a space, around a corner or simply deviate from their gravitational directive. As such, this fixture is designed to be hung from any number of optional swag points mounted elsewhere from the canopy.

57 is an exploration of a technique used for producing closed cell foam. The process involves trapping voids of air of different sizes and configurations within a glass matrix, yielding a shape loosely referencing a rain cloud. These pockets of air remain invisible when the piece is off, but come alive to reveal an interior universe when the piece is illuminated. By virtue of the fabrication process, each piece is completely unique.

NOTES

+ Purchase replacement lamps online at www.bocci.ca/lamps

EU Patent # 002268581-0001 to 0006
Worldwide patents issued and pending

Made in Vancouver, Canada

Vancouver
sales@bocci.ca
www.bocci.ca

Berlin
europe@bocci.ca
www.bocci.ca

approx 11kg (25lb)

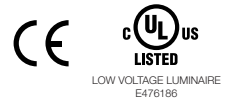

CLUSTER

57.7

Design by Omer Arbel
PRODUCT SPECIFICATION

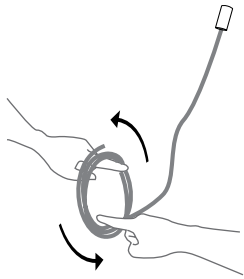

1

Very carefully uncoil the braided coaxial cable in a spool like manner. Insert your index fingers into opposite sides of the roll then rotate your fingers around each other to unroll the coaxial cable.

Use patience: allow the cable to uncoil completely to avoid kinks.

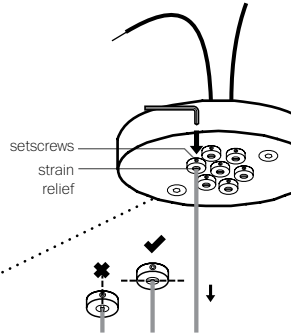

2

Thread the coaxial cables through the canopy, use a 2mm Allen key to loosen the setscrew in the canopy and gently feed the cable through until you have reached your desired drop length.

Use Allen key to tighten the setscrew to hold the strain relief and secure the coaxial cable at its new length. Perform a gentle tug test to ensure it is secure.

DO NOT OVERTIGHTEN.

Note: The strain relief is a black plastic collar around the coaxial cable. There is a single slot opening on the side of the strain relief component. It is essential that this opening is oriented at 90 degrees to set screw chamber. There can be no contact between the set screw and the cable.

RISK OF ELECTRIC SHORT!

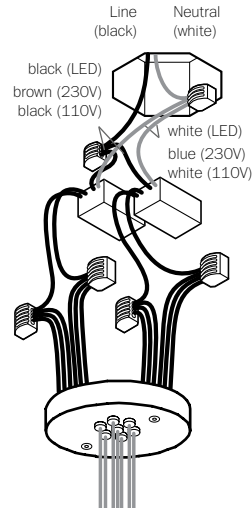

3

LED: connect the black wire to black and white wire to white wire.

Connect the coaxial cable to the open slots in the terminal block on the 12V side of the transformers.

Ensure that the braided outer wires are all connected to one 12V output wire and all inner insulated wires are connected to the other or a short will occur.

Once all coaxial connections are made, lift the fixture into position and connect the line voltage to the open slot in the appropriate terminal block.

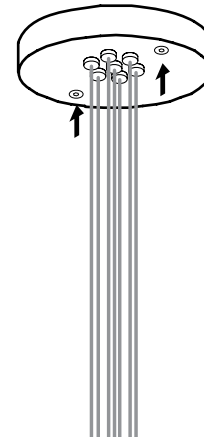

4

The client is responsible to ensure fasteners are attached to a robust structural substrate.

Tuck the transformer and wiring into the canopy. Line up the fastener holes or connect directly to structural ceiling surface using the fasteners provided.

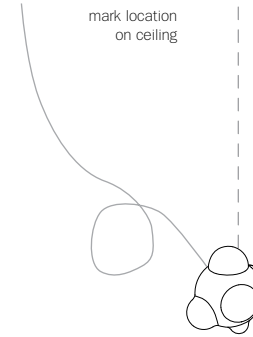

5

Move pendant into location and mark the location for the swag hook screw on the ceiling.

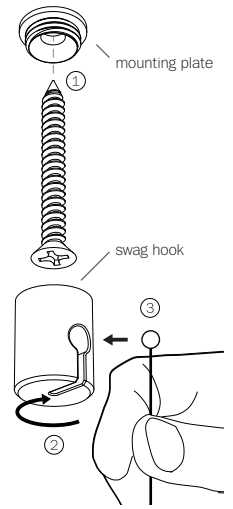

6

Ensure that the ceiling at the swag location is strong enough to hold 2kg (5lbs) before attaching swag hook with the provided screws.

Thread the swag hook on to the mounting plate, ensuring all the threads are engaged.

Slide the ball end of the aircraft into the slot on the swag hook.

CLUSTER

57.7

Design by Omer Arbel
PRODUCT INSTALLATION INSTRUCTIONS

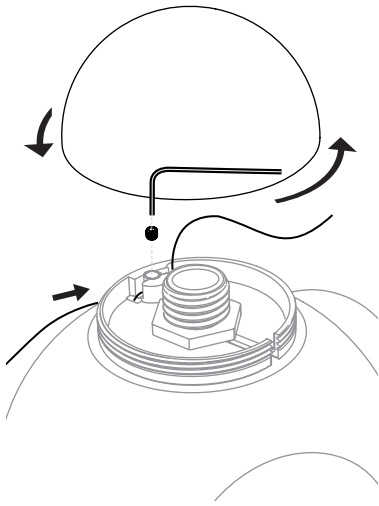

8

Remove the glass cap by turning counter-clockwise and set aside.

Note: throughout the installation, be mindful not to damage the glass cap and do not lose track of it, its size was chosen specifically for this pendant.

Using a 2mm Allen key, loosen the set screw on the hardware. Insert the aircraft cable into the small hole.

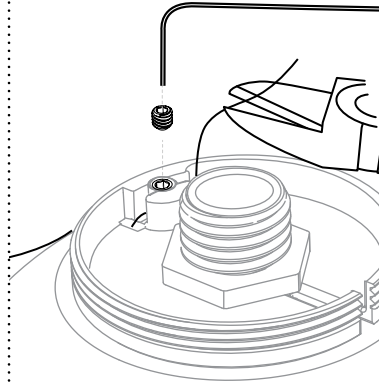

9

Once the pendant is positioned at the desired height, tighten the set screw to lock in the aircraft cable.

Using wire cutters, trim off any excess aircraft cable.

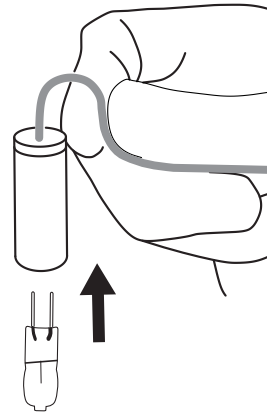

10

Form a hook-shape in the coax right above the lampholder pinching it together over your index finger or thumb. The lampholder should be roughly 90 degrees to the rest of the length of coax.

Bocci 1.8w LED lamps included.

Plug the lamp into the socket. Do not touch the lamp with your bare hands.

Purchase replacement lamps online at www.bocci.ca/lamps

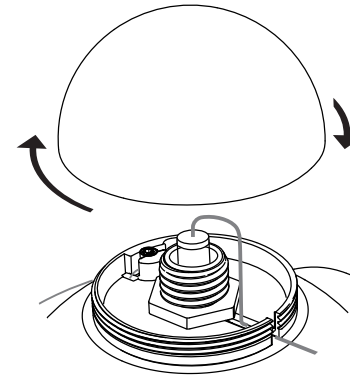

11

Insert the lampholder into the pendant through the hole in the centre of the cap mount. Set it in such a way that the crook rests parallel to the cap mount and runs through the slot with the lampholder inside the pendant perpendicular to the cap mount.

Put the cap back onto the pendant, ensuring that the coax remains seated in the slot. Thread the cap onto the mount.

DO NOT OVERTIGHTEN.

There should be a 2mm gap between the cap and the pendant with the coax emerging from inside.

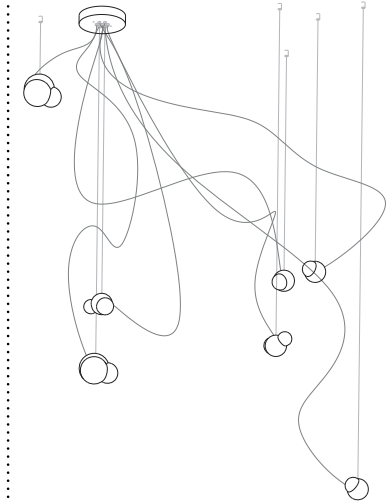

12

Clean fingerprints from glass surfaces.

Turn fixture on.

For additional assistance, please contact Bocci:

Vancouver
sales@bocci.ca
www.bocci.ca

Berlin
europe@bocci.ca
www.bocci.ca

EU Patent # 002268581-0001 to 0006
Worldwide patents issued and pending

Made in Vancouver, Canada

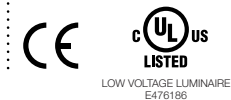

CLUSTER

57.7

Design by Omer Arbel
PRODUCT INSTALLATION INSTRUCTIONS

© 2017, Bocci Design and Manufacturing Inc. All rights reserved. Any inquiries should be directed to: info@bocci.ca

BOCCI

120/240V LED Driver - 4W

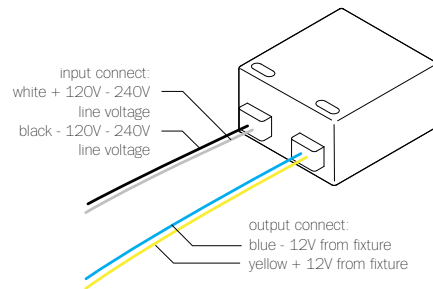

B-L03U-12V

PRIMARY: AC 100 - 240V, 120mA, 50/60Hz

SECONDARY: Max. 12V DC (4.2w max.)

LAMPING: 1w LED lamps: 1-3
1.5w LED lamps: 1-2
1.8w LED lamps: 1-2
2.3w ring LED lamps: 1

DIMMING: Non-dimmable

NOTES: Constant voltage
Class 2 power unit
For LED lamps only

DIMENSION: 43mm (1.7") x 41mm (1.6") x 22mm (0.8")

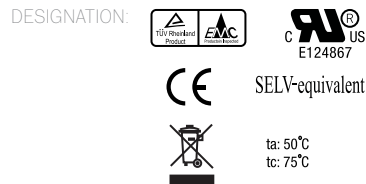

120/240V LED Driver - 8W

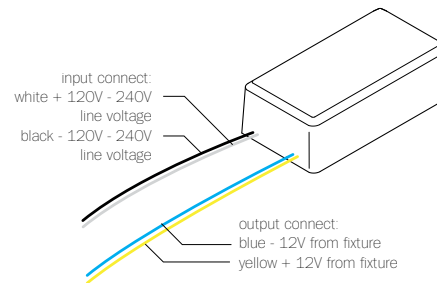

B-L07U-12V

PRIMARY: AC 100 - 240V, 170mA, 50/60Hz

SECONDARY: Max. 12V DC (8.4w max.)

LAMPING: 1w LED lamps: 1-7
1.5w LED lamps: 1-5
1.8w LED lamps: 1-4
2.3w ring LED lamps: 1-3

DIMMING: Non-dimmable

NOTES: Constant voltage
Class 2 power unit
For LED lamps only

DIMENSION: 65mm (2.5") x 35mm (1.3") x 28mm (1.1")

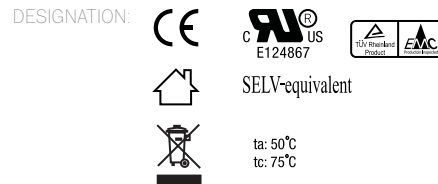

120/240V LED Driver - 24W

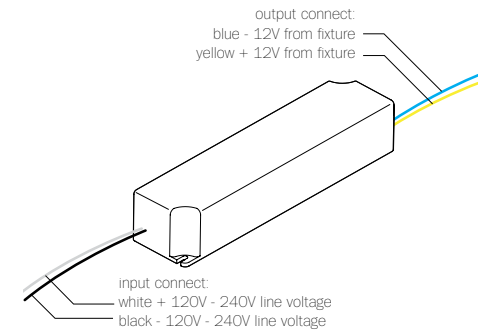

B-L24U-12V

PRIMARY: AC 100 - 240V, 300mA, 60Hz

SECONDARY: Max. 12V DC (24w max.)

LAMPING: 1w LED lamps: 1-24
1.5w LED lamps: 1-16
1.8w LED lamps: 1-13
2.3w ring LED lamps: 1-10

DIMMING: Dimmable using minimum 8 lamps and improves with larger load. Use low voltage electronic dimmers only

NOTES: Short Circuit Protection
Constant voltage
Class 2 power unit
For LED lamps only

DIMENSION: 42mm (1.7") x 170mm (6.7") x 33mm (1.3")



LED

1.8W

Design by Omer Arbel
PRODUCT SPECIFICATION

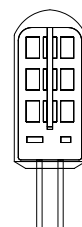
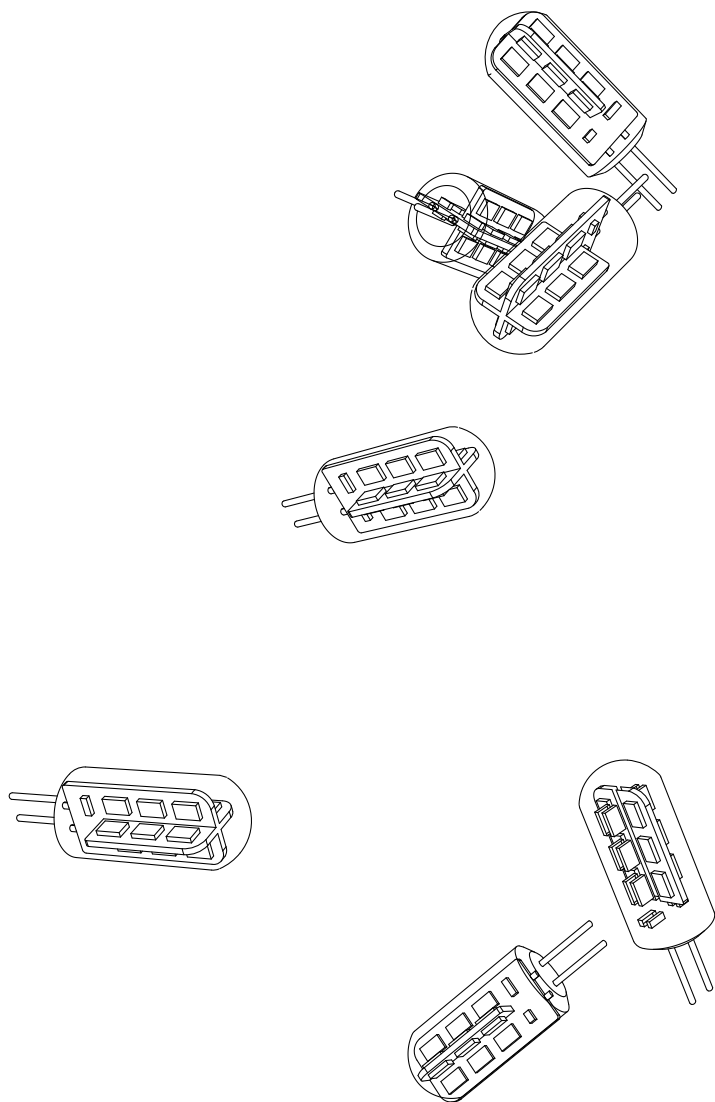

38 (1.5")



12.5 (0.5")

WATTAGE: 1.8w
 COLOUR TEMPERATURE: 2600k
 CRI: 75 (100 is daylight)
 LIGHT OUTPUT: 142 lumens
 EFFICIENCY: 60 lm/w
 LAMP LIFE: 25,000 hours

DESCRIPTION

The Bocci 1.8w LED lamping option offers a longer-life, energy efficient alternative to typical halogen or xenon lamps. This proprietary and worldwide patent pending design utilizes Bocci's standard G4 lamp holder (9.1mm/0.36" in diameter), which is designed to accept either the Bocci xenon lamp or the Bocci LED lamp. The possibility of dual usage allows the opportunity for existing chandeliers with xenon lamping to be retrofitted on site to LED along with the appropriate driver.

This unique replacement design is unlike typical embedded xenon fixtures as it eliminates the waste associated with catastrophic failures that leave no choice but to replace the entire fixture. When it comes time to relamp, the xenon heads may simply be replaced, as with conventional lamps. Bocci xenon lamp keeps the fixture out of landfills in the future, protects your investment and introduces a significant saving of energy.

NOTES

+ Purchase replacement lamps online at www.bocci.ca/lamps

RoHS 

Vancouver
sales@bocci.ca
www.bocci.ca

Berlin
europe@bocci.ca
www.bocci.ca