

# BUSTER + PUNCH

## HARDWARE / DOOR LEVER HANDLE

TECH SPEC



### DOOR LEVER HANDLE

A lever door handle made from solid metal. A solid bar with diamond-cut knurled detailing, ensuring pleasure with every touch. Works great on all internal doors and can be teamed up with our matching door accessories. Available in 4 metal finishes using brushed brass, steel, smoked bronze and black.

[busterandpunch.com](http://busterandpunch.com)  
[info@busterandpunch.com](mailto:info@busterandpunch.com)



**DOOR LEVER HANDLE / 38 MM UNSPRUNG**

TECH SPEC

**38 UNSPRUNG / SUITABLE FOR THE UK**

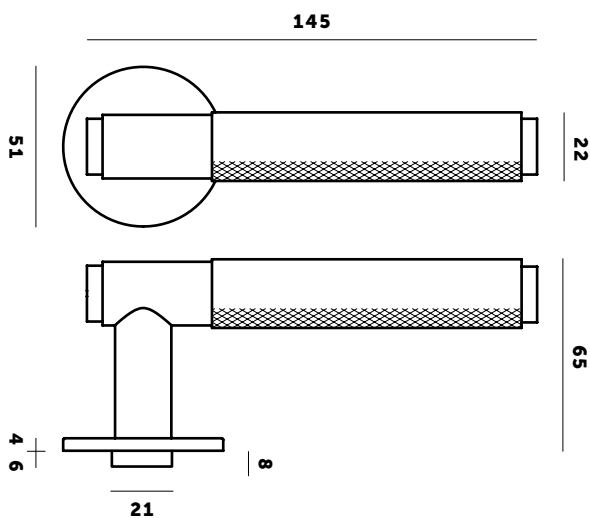

**PRODUCT INFORMATION:**

**Type:** 38 mm\* UNSPRUNG\*\* – for use with heavy sprung locks & latches.

**Use:** interior doors

**Fixings:** Bolt-through fixings included.

**Lock:** Use heavy duty, bolt-through (heavily sprung)\*\*\*

**Door thickness:** 35 - 54 mm thick.

**Rose:** Pair of concealed fixing roses – slim profile, clip fit.

**Box includes:** 1 x pair of door handles, 1 x square bar & screw fittings.

**Material:** solid steel, brass or smoked bronze

**Lever length:** 145 mm

**Lever width:** 22 mm

**Lever depth:** 22 mm

**Rose:** 51 x 4 mm

**Projection:** 61 mm

**Square bar size:** 8 mm

**Care instructions:**

Wipe with damp cloth with no loose hairs, avoid using any chemicals. Please note all finishes are prone to aging.

**FIXINGS**

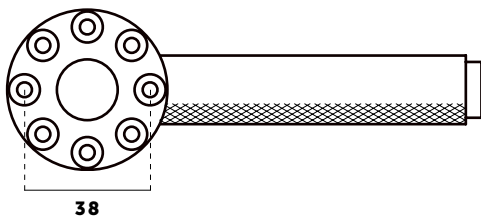

A cover plate is included to cover the screw holes

\*This number indicates the cc millimetre measurement for the screw holes that are used to fit the round plate to the door. 38 mm is standard for the UK and some parts of Europe, 30 mm is standard for Sweden and most of Scandinavia.

\*\*Springs are located in the Lever Handle and/or in the internal latch - to return the handle to the horizontal position after use. Please make sure if you select UNSPRUNG lever handle you specify a heavy duty latch powerful enough to return the lever handle to the original position.

Please select SPRUNG version if your door latch requires assistance to spring back to the original position. The rose on an sprung handle is thicker in profile than a unsprung handle due to the spring mechanics built in.

\*\*\*Recommended locks & latches from ZOO Hardware:

Internal Latch (Tubular) **ZOO ZTLKA76HD**



Bathroom Lock: **ZOO ZTDA76**

Latch & Lock Key: **ZOO ZBSS**

Plate Covers: **ZOO ZLAP01**

Bathroom Plates: **ZOO ZLAP02**

**FINISH**

-  Steel
-  Brass
-  Smoked Bronze

**SKU**

**UK-LH-U-38-ST-A**

**UK-LH-U-38-BR-A**

**UK-LH-U-38-SM-A**

# BUSTER + PUNCH

## DOOR LEVER HANDLE / 38 MM SPRUNG

### TECH SPEC

#### 38 SPRUNG / SUITABLE FOR THE UK

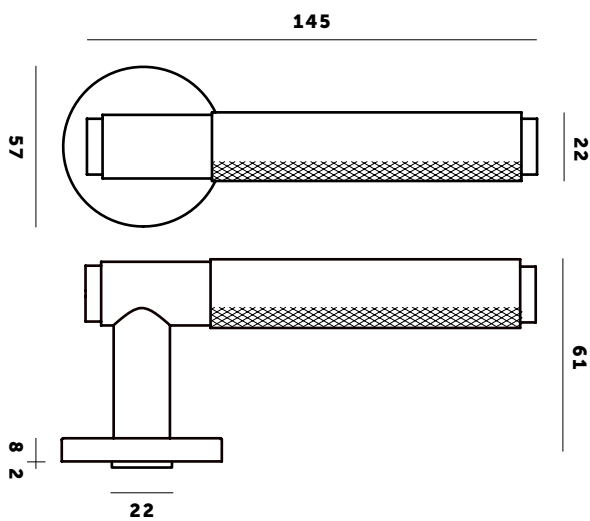

#### PRODUCT INFORMATION

**Type:** 38 mm\* SPRUNG\*\* – for use with heavy sprung locks & latches.

**Use:** Interior doors

**Fixings:** Fixings included.

**Lock:** Use heavy duty, bolt-through (heavily sprung)\*\*\*

**Door thickness:** 35 - 54 mm thick.

**Rose:** Pair of concealed fixing roses – clip fit.

**Box includes:** 1 x Pair of door handles, 1 x square bar & screw fittings.

**Material:** Solid steel, brass or smoked bronze

**Lever length:** 145 mm

**Lever width:** 22 mm

**Lever depth:** 22 mm

**Rose:** 57 x 8 mm

**Projection:** 61 mm

**Square bar size:** 8 mm

#### FIXINGS

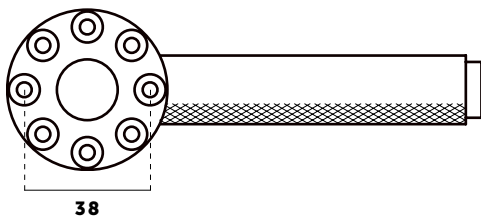

A cover plate is included to cover the screw holes

#### Care instructions:

Wipe with damp cloth with no loose hairs, avoid using any chemicals. Please note all finishes are prone to aging.

\*This number indicates the cc millimetre measurement for the screw holes that are used to fit the round plate to the door. 38 mm is standard for the UK and some parts of Europe, 30 mm is standard for Sweden and most of Scandinavia.

\*\*Springs are located in the Lever Handle and/or in the internal latch - to return the handle to the horizontal position after use. Please make sure if you select UNSPRUNG lever handle you specify a heavy duty latch powerful enough to return the lever handle to the original position.

Please select SPRUNG version if your door latch requires assistance to spring back to the original position. The rose on an sprung handle is thicker in profile than a unsprung handle due to the spring mechanics built in.

\*\*\*Recommended locks & latches from ZOO Hardware:

Internal Latch (Tubular) **ZOO ZTLKA76HD**





Bathroom Lock: **ZOO ZTDA76**

Latch & Lock Key: **ZOO ZBSS**

Plate Covers: **ZOO ZLAP01**

Bathroom Plates: **ZOO ZLAP02**

#### FINISH

-  Steel
-  Brass
-  Smoked Bronze
-  Black

#### SKU

**UK-LH-S-38-ST-A**

**UK-LH-S-38-BR-A**

**UK-LH-S-38-SM-A**

**UK-LH-S-38-BL-A**

# BUSTER + PUNCH

## DOOR LEVER HANDLE / 30 MM UNSPRUNG

### TECH SPEC

#### 30 UNSPRUNG / SUITABLE FOR SWE

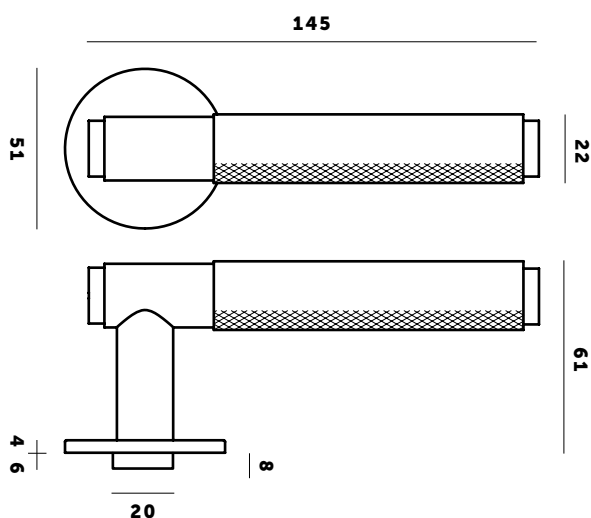

#### PRODUCT INFORMATION

**Type:** 30 mm\* UNSPRUNG\*\* – for use with heavy sprung locks & latches.

**Use:** Interior doors

**Fixings:** Bolt-through fixings included.

**Lock:** Use heavy duty, bolt-through (heavily sprung)\*\*\*

**Door thickness:** 35 - 54 mm thick.

**Rose:** Pair of concealed fixing roses – slim profile, clip fit.

**Box includes:** 1 x Pair of door handles, 1 x square bar & 2 x screw fittings.

**Material:** Solid steel, brass or smoked bronze

**Lever length:** 145 mm

**Lever width:** 22 mm

**Lever depth:** 22 mm

**Rose:** 51 x 4 mm

**Projection:** 61 mm

**Square bar size:** 8 mm

#### Care instructions:

Wipe with damp cloth with no loose hairs, avoid using any chemicals. Please note all finishes are prone to aging.

#### FIXINGS

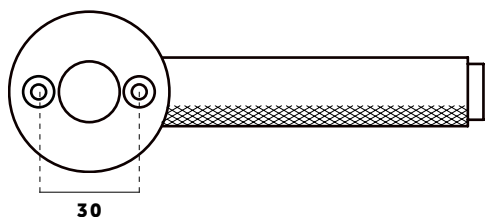

A cover plate is included to cover the screw holes



\*This number indicates the cc millimetre measurement for the screw holes that are used to fit the round plate to the door. 38 mm is standard for the UK and some parts of Europe, 30 mm is standard for Sweden and most of Scandinavia.

\*\*Springs are located in the Lever Handle and/or in the internal latch - to return the handle to the horizontal position after use. Please make sure if you select UNSPRUNG lever handle you specify a heavy duty latch powerful enough to return the lever handle to the original position.

Please select SPRUNG version if your door latch requires assistance to spring back to the original position. The rose on an sprung handle is thicker in profile than a unsprung handle due to the spring mechanics built in.

\*\*\*Recommended locks & latches from ASSA:  
Interior & bathroom doors: **ASSA 2020, 2014**

#### FINISH

-  Steel
-  Brass
-  Smoked Bronze

#### SKU

**SW-LH-U-30-ST-A**

**SW-LH-U-30-BR-A**

**SW-LH-U-30-SM-A**

## DOOR LEVER HANDLE

1. Unscrew and remove end cap by hand.

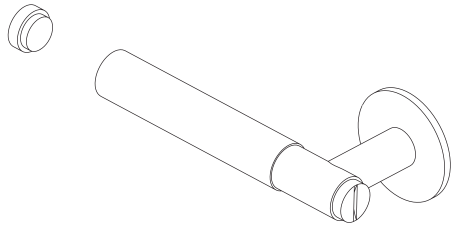

2. Insert crosshead (Phillips) screwdriver into end of handle and unscrew screw until handle can be removed.

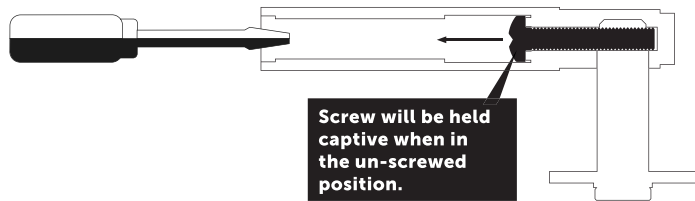

3. Remove handle from axle.

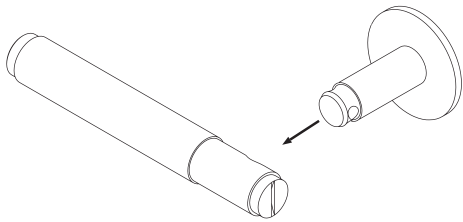

4. Pull back plate cover to gain access to screws.

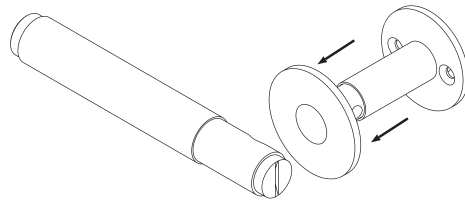

5. Fit handle using the square bar and screws provided. You might need to cut the screws to properly fit your door.

Tighten the handle at the inner engraved lines for a 35 mm door, and the outer lines for a 44 mm door.

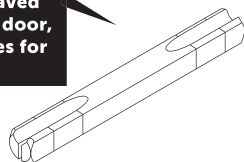

Fit through bolts with the bolt nut.

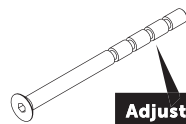

Adjust length by cutting the screw.



6. Fit the screws as the diagram shows.

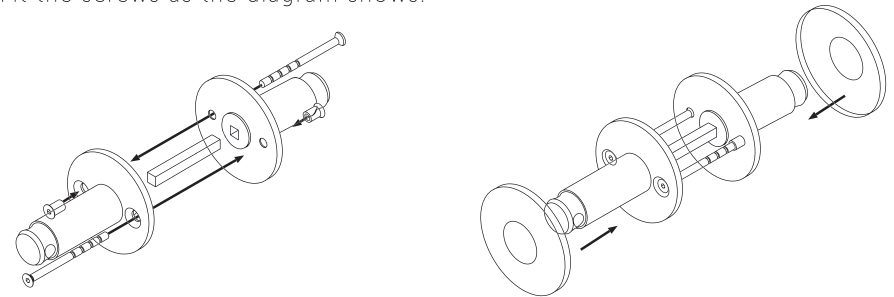

7. Reverse procedure to fix back together. Tighten the screw under the bar with a cross head screwdriver to straighten the handle.

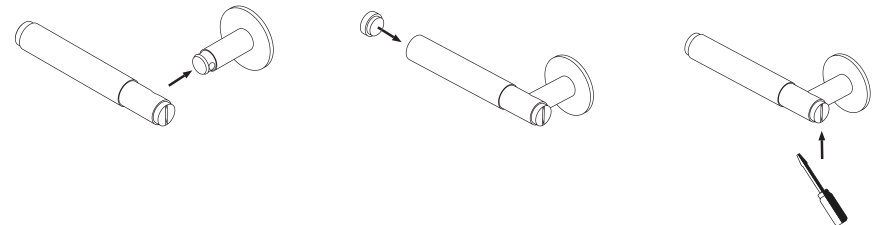

BUSTERANDPUNCH.COM

BUSTER + PUNCH

HARDWARE  
DOOR LEVER HANDLE  
30 MM UNSPRUNG

SKU# UK-LH-S-30\*\*

### Contents

- 1x Square bar
- 2x Through bolts + nuts

### CARE INSTRUCTIONS

Use mild detergent and soft damp cloth

