

# 28

cluster

An innovative fabrication process that manipulates both the temperature and the direction of air flow into blown glass. The result is a slightly distorted sphere with an interior landscape of satellite shapes, including an opaque milk glass diffuser that houses either a low-voltage xenon or LED lamp.

The Cluster is suspended using coaxial cable and composed in hexagonal clusters in numerous configurations.



**BOCCI**

# 28

cluster

## Lamping

1.8w LED or 20w xenon

## Material

Blown glass, braided metal coaxial cable, electrical components, and brushed nickel or white powder coated canopy.

## Patent

US Patent # D687,740  
EU Patent # 001695834-001 to 004



±165 (6.5")

# 28

cluster

Adjustable Lengths  
Cluster canopies.

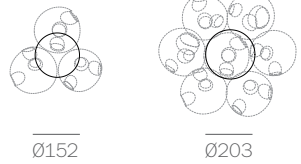
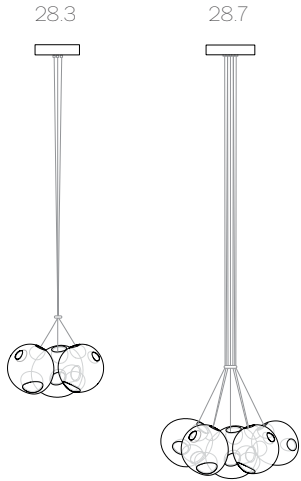

adjustable up to 3000 (10') standard  
adjustable up to 30500 (100') custom

Fixed Lengths  
Cluster canopies.

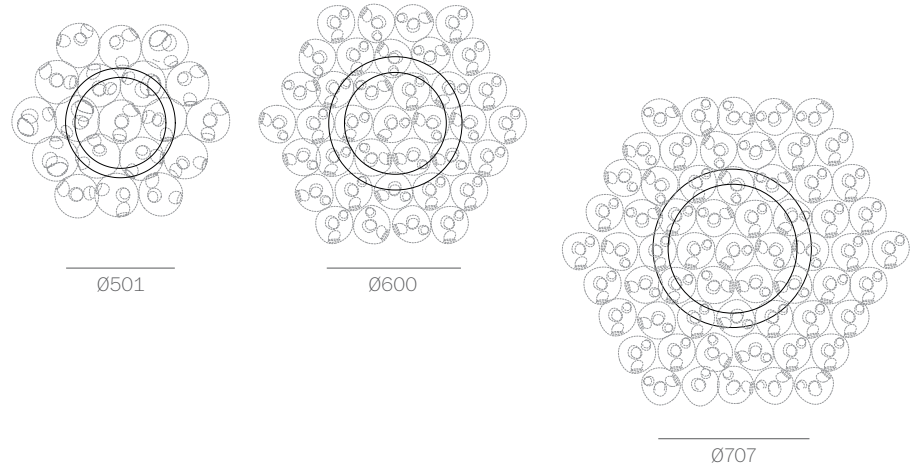
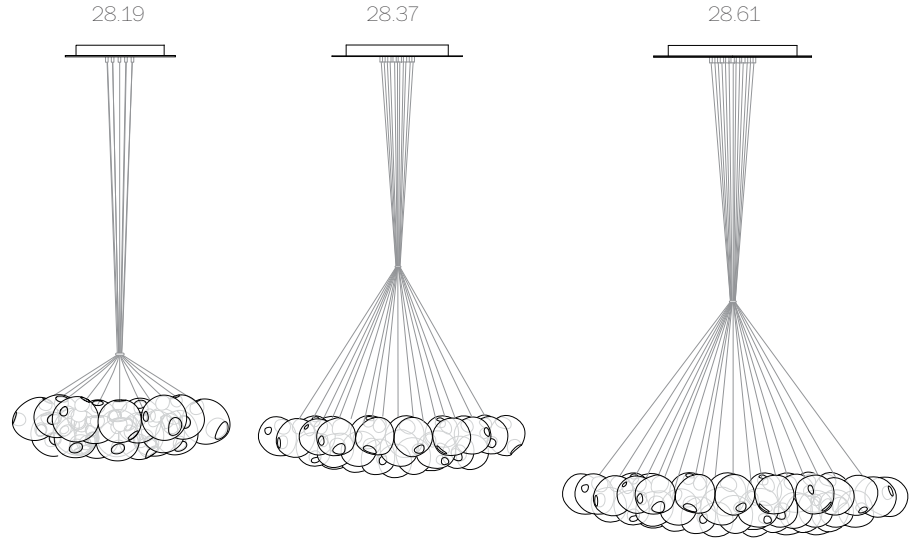

fixed length up to 3000 (10') standard  
fixed length up to 30500 (100') custom

# 28

cluster

The 28 pendant comes in 90 different colours. Please visit the [28 colour app](#) for pendant colour compositions.

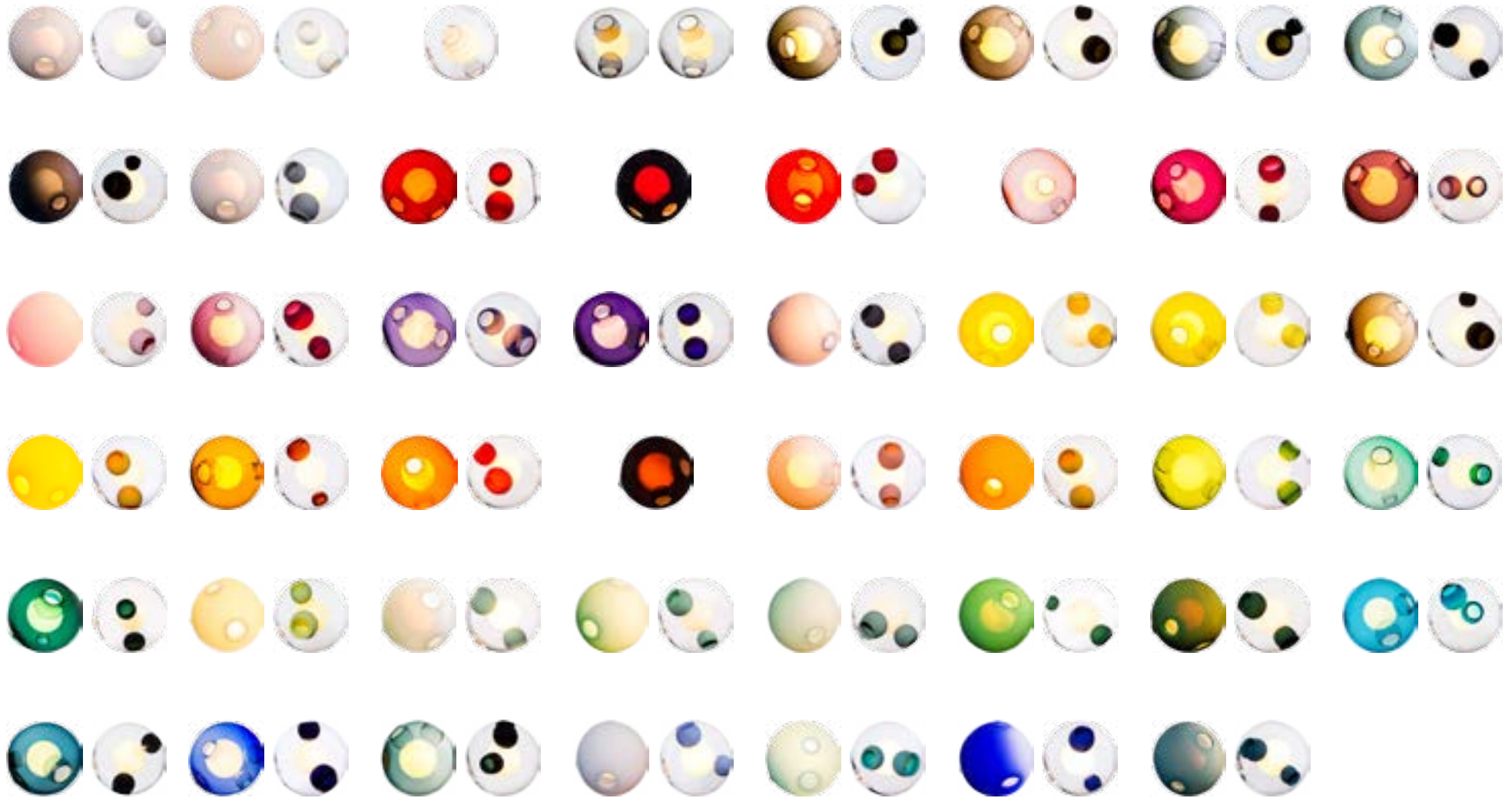

# 28

cluster





28  
cluster



Designed by Omer Arbel, 2009  
[www.bocci.ca](http://www.bocci.ca)



**BOCCI**

© 2018, Bocci Design and Manufacturing Inc.  
Any inquiries should be directed to: [info@bocci.ca](mailto:info@bocci.ca)

28  
cluster





28  
cluster





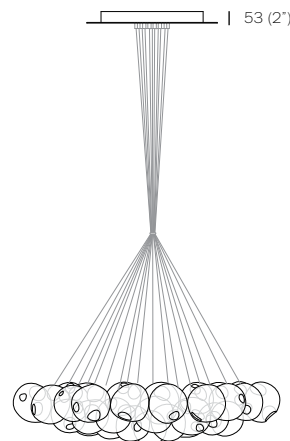
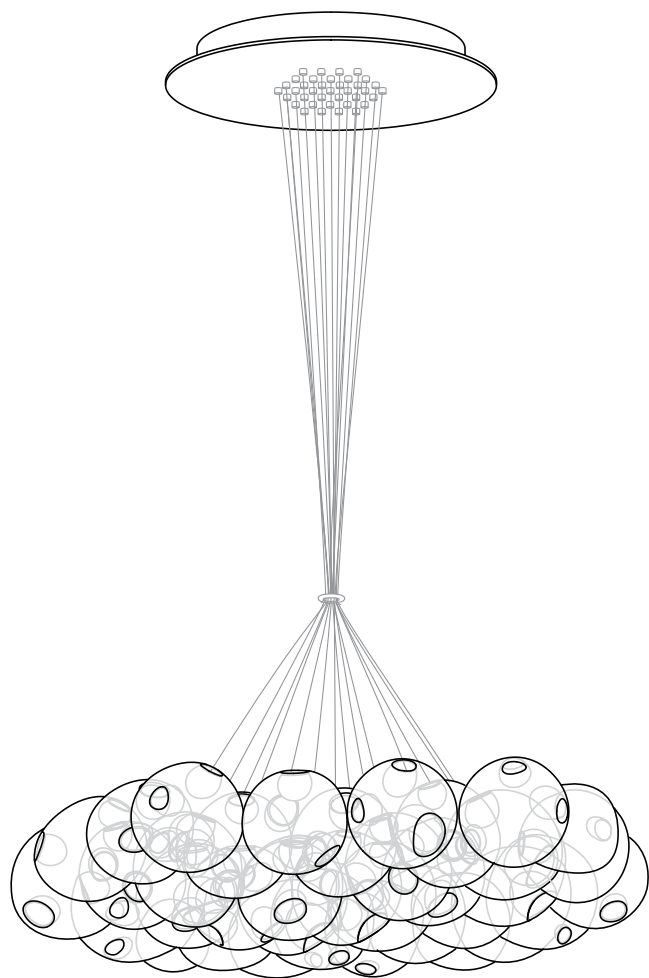

up to  
3000  
(10')  
standard

up to  
30500  
(100')  
custom

min.  
drop length  
1100  
(43.3')

±165 (6.5')

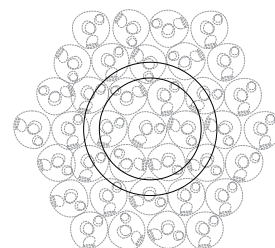

470 (18.5')

600 (23.6')

±1050 (41')

PENDANTS: thirty-seven

MOUNTING: white powder coated round canopy 600mm (23.6") in diameter x 53mm (2") deep

LAMPING: 1.8w LED or 20w xenon

COAX: fixed lengths. 3000mm (10') standard / up to 30500mm (100') maximum

MATERIALS: blown glass, braided metal coaxial cable, electrical components, brushed nickel canopy

WEIGHT: approximately 71.5kg (158lb)

TRANSFORMERS: integral

## DESCRIPTION

28.37 is a cluster of thirty-seven 28 pendants hung from a round canopy. The pendants hang in shape of a hexagonal bouquet, bundled together by an adjustable ring, which changes the curvature of the piece and its proportional reading.

28 is an exploration of specificity in manufacturing. Instead of designing form itself, here the intent was to design a system of making that yields form. Individual 28 pendants result from a complex glass blowing technique whereby air pressure is intermittently introduced into and then removed from a glass matrix which is intermittently heated and then rapidly cooled. The result is a distorted spherical shape with a composed collection of imploded inner shapes, one of which acts as a shade for the light source.

Standard 28s are made with clear glass exterior spheres and milk white interior lamp holder cavities. 28s are possible with infinite versatility in colour compositions, sizes and shapes.

## NOTES

- + Purchase replacement lamps online at [www.bocci.ca/lamps](http://www.bocci.ca/lamps)
- + Unless otherwise noted when ordering, all fixtures will be outfitted to be xenon compatible
- + As an alternative to built-in transformers, Bocci recommends mounting transformers remotely in an easily accessible and hidden location for ease of long-term maintenance.

US Patent # D687,740

EU Patent # 001695834-001 to 004

Made in Vancouver, Canada

Vancouver  
sales@bocci.ca  
www.bocci.ca

Berlin  
europe@bocci.ca  
www.bocci.ca

approx 71.5kg (158lb)



CLUSTER

# 28.37

Design by Omer Arbel  
PRODUCT SPECIFICATION

© 2018, Bocci Design and Manufacturing Inc. All rights reserved. Any inquiries should be directed to: [info@bocci.ca](mailto:info@bocci.ca)

# BOCCI

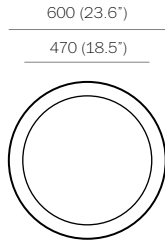

1

Measure and mark the light fixture canopy position on the ceiling

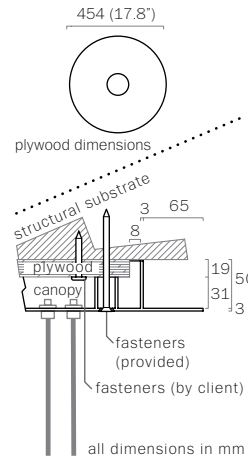

2

Note: The client is responsible for providing a robust 19mm (3/4") plywood backing or wood blocking to securely anchor to the structural substrate.

Connections from the plywood to the structural substrate are the client's responsibility.

Measure the plywood so that it fits within the canopy side walls (refer to detail above).

Anchor the plywood backing to the structural ceiling substrate.

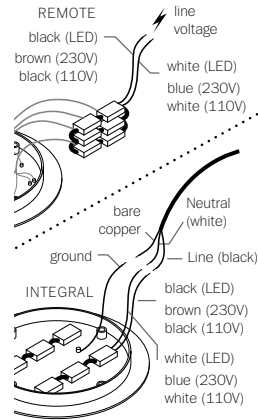

3

Connect transformers inside the canopy to line voltage.

Xenon (110V) or LED: connect the black wire to black and white wire to white wire.

Xenon (230V): connect black wire to brown wire and white wire to blue wire.

For the ground connection, connect the green wire with yellow stripe to the bare copper wire or green wire in the junction box.

Note: As an option, Bocci recommends mounting transformers remotely in a close, accessible and hidden location for ease of long term maintenance. Installation to be done by certified personnel to insure compliance with the code.

4

Anchor canopy into the plywood backing using the fasteners provided.

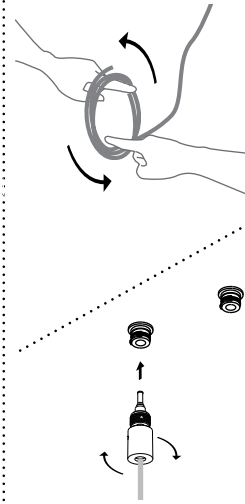

5

Very carefully uncoil the braided coaxial cable in a spool like manner. Insert your index fingers into opposite sides of the roll then rotate your fingers around each other to unroll the coaxial cable.

Use patience: allow the cable to uncoil completely to avoid kinks.

Each pendant terminates in a "headphone jack" type connector, which plugs into a receiving receptacle in the canopy. Clients are encouraged to compose their own pendant configuration on site, thus creating a truly unique fixture. After plugging in each pendant, turn the threaded sheath into place by hand ensuring that it is adequately tightened. Tools are not required.

Note: The glass pendants function as a heat sink for the xenon lamps. Please do not leave the fixture on without the pendants installed as it can cause the lamps to overheat and stop working.

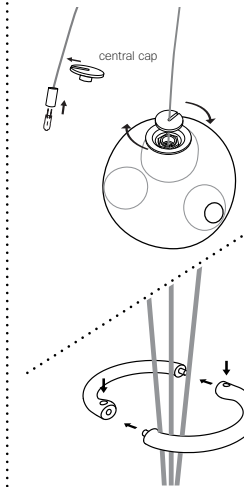

6

Bocci lamps are included. Plug the lamp into the socket. Do not touch the lamp with your bare hands.

Remove the center cap from 28 pendant. Install 28 pendant by sliding the center cap onto the coaxial cable, gently insert the lamp into the pendant, then tighten the center cap connection by hand.

DO NOT OVERTIGHTEN.

Remove the protective film from the center cap after assembly.

Note: when using a dimmer use only low voltage electronic dimmer.

Prior to installing the ring around the coaxial cables, ensure that the pendants are composed in their intended hexagonal formation.

Gather the coaxial cables then install the ring with setscrews face up.

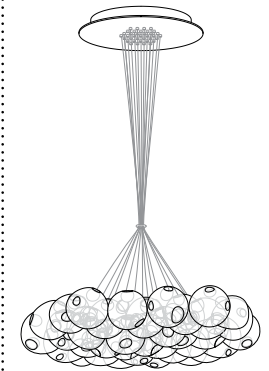

7

Clean fingerprints from glass surfaces.

Turn fixture on.

For additional assistance, please contact Bocci:

Vancouver  
sales@bocci.ca  
www.bocci.ca

Berlin  
europe@bocci.ca  
www.bocci.ca

US Patent # D687,740  
EU Patent # 001695834-001 to 004

Made in Vancouver, Canada

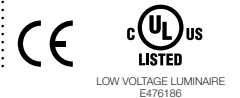

CLUSTER

28.37

Design by Omer Arbel  
PRODUCT INSTALLATION INSTRUCTIONS

© 2018, Bocci Design and Manufacturing Inc. All rights reserved. Any inquiries should be directed to: info@bocci.ca

BOCCI

## 120/240V LED Driver - 4W

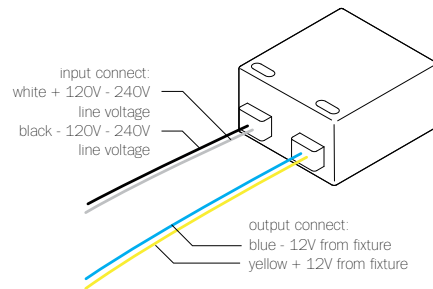

### B-L03U-12V

PRIMARY: AC 100 - 240V, 120mA, 50/60Hz

SECONDARY: Max. 12V DC (4.2w max.)

LAMPING: 1w LED lamps: 1-3  
1.5w LED lamps: 1-2  
1.8w LED lamps: 1-2  
2.3w ring LED lamps: 1

DIMMING: Non-dimmable

NOTES: Constant voltage  
Class 2 power unit  
For LED lamps only

DIMENSION: 43mm (1.7") x 41mm (1.6") x 22mm (0.8")

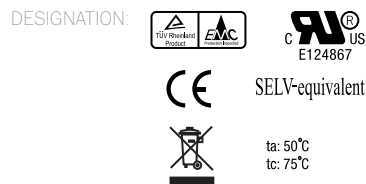

## 120/240V LED Driver - 8W

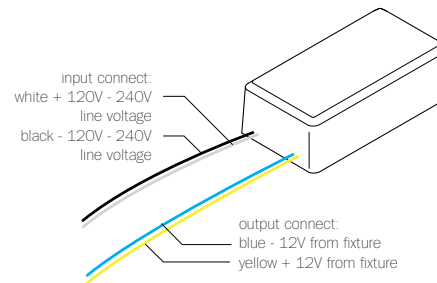

### B-L07U-12V

PRIMARY: AC 100 - 240V, 170mA, 50/60Hz

SECONDARY: Max. 12V DC (8.4w max.)

LAMPING: 1w LED lamps: 1-7  
1.5w LED lamps: 1-5  
1.8w LED lamps: 1-4  
2.3w ring LED lamps: 1-3

DIMMING: Non-dimmable

NOTES: Constant voltage  
Class 2 power unit  
For LED lamps only

DIMENSION: 65mm (2.5") x 35mm (1.3") x 28mm (1.1")

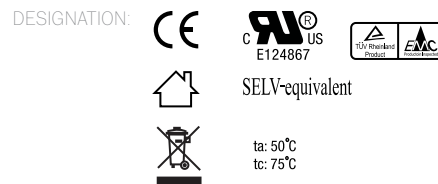

## 120/240V LED Driver - 24W

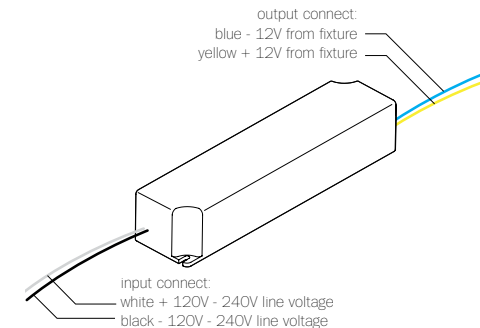

### B-L24U-12V

PRIMARY: AC 100 - 240V, 300mA, 60Hz

SECONDARY: Max. 12V DC (24w max.)

LAMPING: 1w LED lamps: 1-24  
1.5w LED lamps: 1-16  
1.8w LED lamps: 1-13  
2.3w ring LED lamps: 1-10

DIMMING: Dimmable using minimum 8 lamps and improves with larger load. Use low voltage electronic dimmers only

NOTES: Short Circuit Protection  
Constant voltage  
Class 2 power unit  
For LED lamps only

DIMENSION: 42mm (1.7") x 170mm (6.7") x 33mm (1.3")





## 120V Transformer

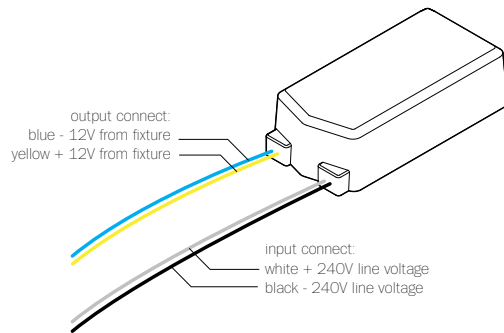

### WH-601E6A-3C

PRIMARY: AC 120V 50/60Hz, 500mA

SECONDARY: 12V AC (10w min. - 60w max.)

LAMPING: 10w lamps: 1-6  
20w lamps: 1-3

DIMMING: Dimmable using minimum 2 x 10w lamps or 1 x 20w lamp using low voltage electronic and trailing edge dimmers only.

NOTES: Auto stop protected  
Class 2 power unit  
Electronic transformer for xenon lamps only

DIMENSION: 70mm (2.8") x 36mm (1.4") x 20mm (0.75")

DESIGNATION:  

## 240V Transformer

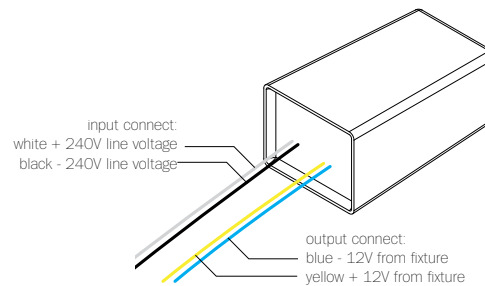

### WH-602W

PRIMARY: AC 230V-240V 50Hz, 260mA

SECONDARY: 11.5V AC (10w min. - 60w max.)

LAMPING: 10w lamps: 1-6  
20w lamps: 1-3

DIMMING: Dimmable using minimum 2 x 10w lamps or 1 x 20w lamp using low voltage electronic and trailing edge dimmers only.

NOTES: Auto stop protected  
Class 2 power unit  
Electronic transformer for xenon lamps only

DIMENSION: 63mm (2.5") x 35mm (1.4") x 26mm (1")

DESIGNATION:    

IP65   ta: 50°C  
tc: 80°C

## 240V Transformer

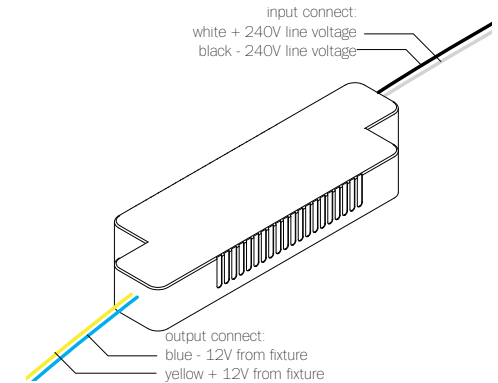

### WH-602S

PRIMARY: AC 230V-240V 50Hz, 260mA









SECONDARY: 11.5V AC (10w min. - 60w max.)

LAMPING: 10w lamps: 1-6  
20w lamps: 1-3

DIMMING: Dimmable using minimum 2 x 10w lamps or 1 x 20w lamp using low voltage electronic and trailing edge dimmers only.

NOTES: Auto stop protected  
Class 2 power unit  
Electronic transformer for xenon lamps only

DIMENSION: 117mm (4.5") x 36mm (1.4") x 16mm (0.6")

DESIGNATION:     
     
 

LED

1.8W

Design by Omer Arbel  
PRODUCT SPECIFICATION

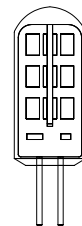
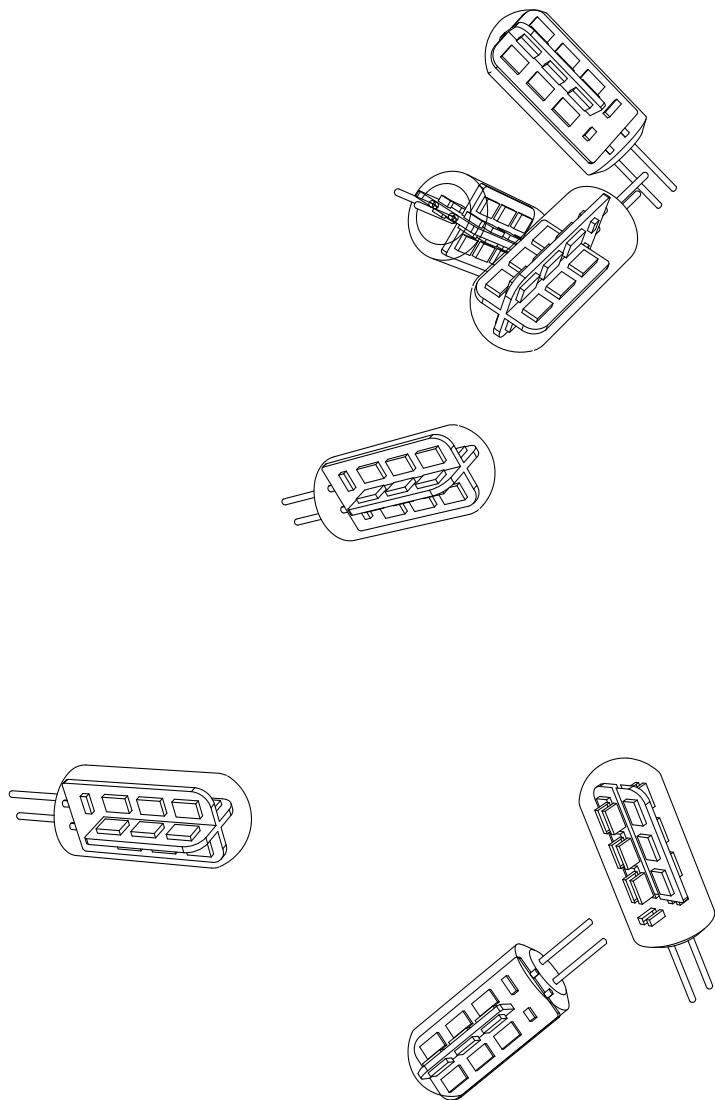

38 (1.5")



12.5 (0.5")

WATTAGE: 1.8w  
 COLOUR TEMPERATURE: 2600k  
 CRI: 75 (100 is daylight)  
 LIGHT OUTPUT: 142 lumens  
 EFFICIENCY: 60 lm/w  
 LAMP LIFE: 25,000 hours

#### DESCRIPTION

The Bocci 1.8w LED lamping option offers a longer-life, energy efficient alternative to typical halogen or xenon lamps. This proprietary and worldwide patent pending design utilizes Bocci's standard G4 lamp holder (9.1mm/0.36" in diameter), which is designed to accept either the Bocci xenon lamp or the Bocci LED lamp. The possibility of dual usage allows the opportunity for existing chandeliers with xenon lamping to be retrofitted on site to LED along with the appropriate driver.

This unique replacement design is unlike typical embedded xenon fixtures as it eliminates the waste associated with catastrophic failures that leave no choice but to replace the entire fixture. When it comes time to relamp, the xenon heads may simply be replaced, as with conventional lamps. Bocci xenon lamp keeps the fixture out of landfills in the future, protects your investment and introduces a significant saving of energy.

#### NOTES

+ Purchase replacement lamps online at [www.bocci.ca/lamps](http://www.bocci.ca/lamps)

RoHS 

Vancouver  
[sales@bocci.ca](mailto:sales@bocci.ca)  
[www.bocci.ca](http://www.bocci.ca)

Berlin  
[europe@bocci.ca](mailto:europe@bocci.ca)  
[www.bocci.ca](http://www.bocci.ca)

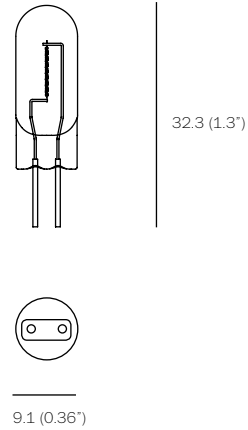
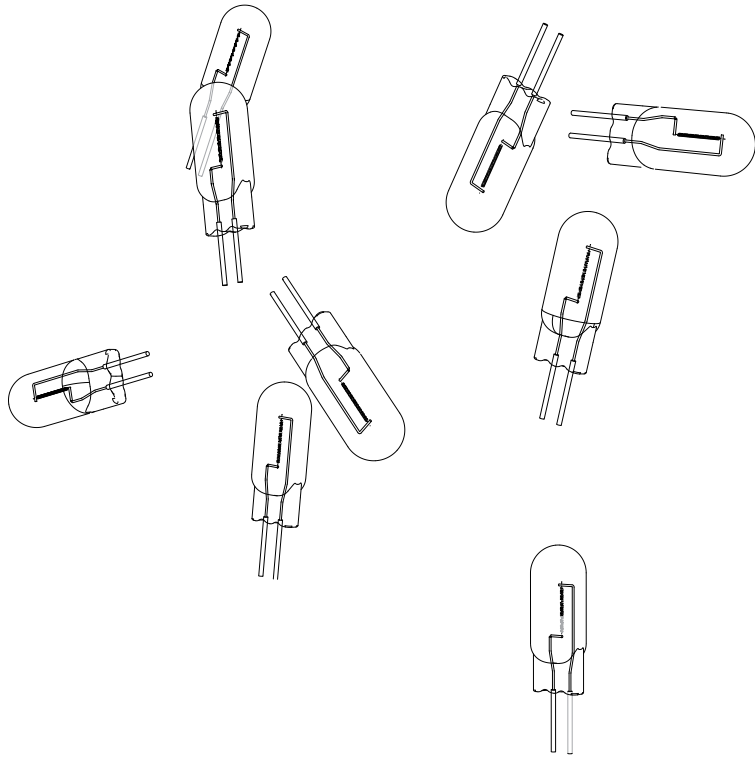

WATTAGE: 20w  
 COLOUR TEMPERATURE: 2600k  
 CRI: 100 (100 is daylight)  
 LIGHT OUTPUT: 196 lumens  
 EFFICIENCY: 19.03 lm/w  
 DIMMABLE: yes  
 LAMP LIFE: 20,000 hours

**DESCRIPTION**

The Bocci 20w xenon lamping option offers a longer-life, energy efficient alternative to typical halogen or xenon lamps. This proprietary and worldwide patent pending design utilizes Bocci's standard G4 lamp holder (9.1mm/0.36" in diameter), which is designed to accept either the Bocci xenon lamp or the Bocci LED lamp. The possibility of dual usage allows the opportunity for existing chandeliers with xenon lamping to be retrofitted on site to LED along with the appropriate driver.

This unique replacement design is unlike typical embedded xenon fixtures as it eliminates the waste associated with catastrophic failures that leave no choice but to replace the entire fixture. When it comes time to relamp, the xenon heads may simply be replaced, as with conventional lamps. Bocci xenon lamp keeps the fixture out of landfills in the future, protects your investment and introduces a significant saving of energy.

**NOTES**

- + Purchase replacement lamps online at [www.bocci.ca/lamps](http://www.bocci.ca/lamps)
- + Requires electronic low-voltage, trailing edge dimmer
- + When replacing, do not touch bulb with bare hands

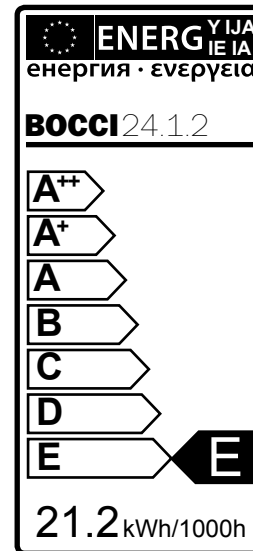

RoHS

Vancouver  
[sales@bocci.ca](mailto:sales@bocci.ca)  
[www.bocci.ca](http://www.bocci.ca)

Berlin  
[europe@bocci.ca](mailto:europe@bocci.ca)  
[www.bocci.ca](http://www.bocci.ca)